

**EPSON® PowerLite® 503c/713c
Multimedia Projector**

User's Guide

Important Safety Information

WARNING: Never look into the projector lens when the lamp is turned on; the bright light can damage your eyes. Never let children look into the lens when it is on. Never open any cover on the projector, except the lamp and filter covers. Dangerous electrical voltages inside the projector can severely injure you. Except as specifically explained in this *User's Guide*, do not attempt to service this product yourself. Refer all servicing to qualified service personnel.

WARNING: The projector and its accessories come packaged in plastic bags. Keep plastic bags away from small children to avoid any risk of suffocation.

Caution: When you replace the lamp, never touch the new lamp with your bare hands; the invisible residue left by the oil on your hands may shorten the lamp life. Use a cloth or glove to handle the new lamp.

Copyright Notice

All rights reserved. No part of this publication may be reproduced, stored in a retrieval system, or transmitted in any form or by any means, electronic, mechanical, photocopying, recording, or otherwise, without the prior written permission of SEIKO EPSON CORPORATION. The information contained herein is designed only for use with this EPSON product. EPSON is not responsible for any use of this information as applied to other products.

Neither SEIKO EPSON CORPORATION nor its affiliates shall be liable to the purchaser of this product or third parties for damages, losses, costs, or expenses incurred by purchaser or third parties as a result of: accident, misuse, or abuse of this product or unauthorized modifications, repairs, or alterations to this product, or (excluding the U.S.) failure to strictly comply with SEIKO EPSON CORPORATION's operating and maintenance instructions.

SEIKO EPSON CORPORATION shall not be liable for any damages or problems arising from the use of any options or any consumable products other than those designated as Original EPSON Products or EPSON Approved Products by SEIKO EPSON CORPORATION.

EPSON is a registered trademark of SEIKO EPSON CORPORATION.

EPSON Connection, EPSON Store, and EPSON Extra Care are service marks; SizeWise is a trademark; and PrivateLine, Presenters Club, and PowerLite are registered trademarks of Epson America, Inc.

General Notice: Other product names used herein are for identification purposes only and may be trademarks of their respective owners. EPSON disclaims any and all rights in those marks.



Printed on recycled paper

Printed in the U.S.A.

Copyright © 2001 by Epson America, Inc.

CPD-12796

8/01

C

Contents

<i>Welcome</i>	1
Getting the Most from Your Projector	2
Using Your Documentation	3
Reading This Manual Online	3
Getting More Information	4
Registration and Warranty	5
Unpacking the Projector	6
Additional Components	7
Optional Accessories	8

1

<i>Setting Up the Projector</i>	9
Positioning the Projector	10
Connecting to a Laptop Computer	12
Connecting the Computer Cable	12
Connecting the Cable for Remote Mouse Control	13
Amplifying Computer Audio	14
Connecting to Video Sources	15
Connecting the RCA A/V Cable	15
Connecting S-Video	16

2

<i>Using the Projector</i>	17
Turning On Your Equipment	18
Turning On the Projector	18
What To Do If You See a Blank Screen	20
Adjusting the Image	22
Focusing and Zooming Your Image	23
Adjusting the Height of Your Image	23
Adjusting the Image Shape	24
Shutting Down the Projector	25

3

<i>Using the Remote Control</i>	27
Turning On and Using the Remote Control	28
Installing Batteries	28
Turning On the Remote Control	28
Using the Remote Control	29
Controlling the Picture and Sound	30
Switching Between Picture Sources	30
Adjusting the Volume	30
Turning Off the Picture and Sound	31
Stopping Action	31
Zooming Your Image	31
Resizing the Image	32
Displaying Picture-in-Picture Video	32
Highlighting Your Presentation	33
Using the Pointer	34
Using Box Highlights	34
Drawing Horizontal and Vertical Lines	35
Drawing Freehand Lines	35
Using the Remote Control as a Wireless Mouse	36

4	<i>Fine-tuning the Projector</i>	37
	Using the Projector's Menu System	38
	Changing Menu Settings	39
	Adjusting the Image	40
	Repositioning the Image	40
	Adjusting Image Appearance	41
	Adjusting the Sound	42
	Customizing the Highlighting Tools	43
	Creating Your Own Startup Screen	44
	Capturing the Image	44
	Selecting When the Image Displays	45
	Customizing Projector Features	46
	Setting Advanced Features	48
	Viewing Lamp Usage and Other Information	49
	Restoring the Default Settings	50

5	<i>Maintaining and Transporting the Projector</i>	51
	Cleaning the Lens	52
	Cleaning the Projector Case	52
	Cleaning and Replacing the Air Filter	53
	Replacing the Lamp	54
	Transporting the Projector	56

6	<i>Solving Problems</i>	57
	Using On-Screen Help	58
	What To Do When the Lights Flash	59
	Solving Problems with the Image or Sound	62
	Solving Problems with the Remote Control	68
	Where To Get Help	69
	Telephone Support Services	69

A	<i>Appendix A: Connecting to Additional Equipment</i>	71
	Installing the Projector	72
	Connecting to an External Audio System	72
	Connecting to a PC Desktop Computer	73
	Connecting the Computer Cable	74
	Connecting the Mouse Cable	75
	Connecting the Audio Cable	76
	Connecting to a Desktop Macintosh	77
	Connecting the Computer Cable	77
	Connecting the Mouse Cable	78
	Connecting the Audio Cable	79
	Connecting to a High-End Workstation	79

B	<i>Appendix B: Notices</i>	81
	Important Safety Instructions	81
	Remote Control Information	83
	Declaration of Conformity	84
	FCC Compliance Statement	85
	Warranty	86

C	<i>Appendix C: Technical Specifications</i>	89
	General	89
	Projection Lamp	90
	Remote Control	90
	Mouse Compatibility	90
	Dimensions	90
	Electrical	90
	Environmental	91
	Safety	91
	Compatible Video Formats	92
	Computer Video Port Pin Assignments	94

	<i>Index</i>	95
--	--------------------	----

W *Welcome*

The EPSON® PowerLite® 503c/713c are super-portable projectors that offer up to 1200 ANSI lumens of brightness. From boardrooms to auditoriums, your full-color presentations and videos will be bright and visible even in ordinary room lighting.

Images are displayed at a resolution of 1024 × 768 pixels (PowerLite 713c) or 800 × 600 pixels (PowerLite 503c). Three 0.9-inch LCDs provide a 400:1 contrast ratio for incredibly vivid images and clear text. Support for S-video contributes to theater-quality performance.

With EPSON's patented SizeWise™ technology, the projector supports computer displays ranging from VGA through UXGA (PowerLite 713c) and from VGA through SXGA (PowerLite 503c).

You can connect the projector to a wide range of computers, including IBM® compatible PCs and laptops, Apple® Macintosh®, Power Macintosh™ series (including G3 and G4 systems), PowerBook® computers, many iMac™ and iBook™ series systems, and high-end workstations such as the Sun® SPARCstation.™

You can use any of the following video sources: VCR, DVD player, camcorder, digital camera, or laser disc player, supporting NTSC, PAL, or SECAM video.

Getting the Most from Your Projector

Depending on your presentation, you can take advantage of any or all of these options:

- **Connecting to a laptop or other computer**

If you want to connect to a PC laptop or Macintosh PowerBook or iBook, see page 12. To connect to a desktop computer or workstation, see Appendix A.

- **Connecting to video sources**

You can connect a DVD player, VCR, camcorder, laser disc player, digital camera, or any other video source to your projector. You can connect both computer and video sources at the same time and easily switch between them. See page 15 for instructions.

- **Using the remote control**

The remote control lets you switch from computer to video source, with access to picture-in-picture, pointer, zoom, and many other projector features. For details, see Chapter 3.

By connecting an additional cable, you can also use the remote control as a wireless mouse. This lets you click through computer-based presentations (such as PowerPoint®) from up to 30 feet away. For more information, see page 36.

- **Including sound in your presentation**

If your presentation includes sound, you can connect an audio cable to use the projector's built-in stereo speakers. For details, see page 14 (for laptops) or Appendix A (for other systems).

You can also connect external speakers or a public address system to the projector's **Audio Out** port; see page 72.

Using Your Documentation

To connect the projector to your laptop and get your presentation running fast, see the *Quick Setup* sheet that came in your *Owner's Kit*.

This book contains all the information you need to set up and use your projector. Please follow these guidelines as you read through it:

- Warnings must be followed carefully to avoid bodily injury.
- Cautions must be observed to avoid damage to your equipment.
- Notes contain important information about your projector.

Reading This Manual Online

Your PowerLite 503c/713c CD-ROM includes an electronic copy of this manual. You may find it convenient to copy it onto your laptop's hard drive so it's always with you—for example, when taking your presentation on the road.

To view your electronic manual, you need to use Adobe® Acrobat® Reader. Just insert the PowerLite CD-ROM in your CD-ROM drive, select the **Install/View User's Guide** button and click **Install User's Guide** or **View User's Guide**.

When you open the manual, you see this toolbar:

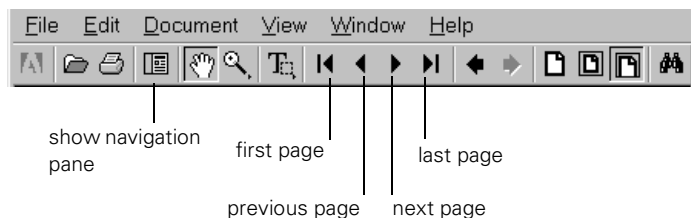

You have several ways to navigate through the manual:

- Click in the table of contents on the left side of the screen to move quickly to the topic of your choice.
- Use the arrow buttons in the toolbar or on the vertical scroll bar on the right side of the screen to move through the manual.

note

If you do not have Acrobat Reader, you can install it from the CD-ROM.

- If you hold your mouse pointer over text and the hand changes to an index finger, you can click to jump to a related topic.

For more information, see your Acrobat Reader online guide.

Getting More Information

Need tips on giving presentations? How about quick steps for setting up your projector? Here's where you can look for help:

- **www.presentersonline.com**
Includes a library of articles covering presentation tips, tricks, and technology. The site provides templates, clip art and sound clips, as well as Presenters Services to use on the road. Even more resources and services are available if you register to join the Presenters Club®—and it's free.
- **Owner's Kit envelope**
Includes your *Quick Setup* sheet, warranty brochures, CD-ROM, and EPSON PrivateLine® Support card. Store this *User's Guide* in the envelope and keep the envelope with your projector at all times.
- **Quick Setup sheet**
Gives you all the instructions you need to get your projector set up and connected to a laptop or PowerBook computer.
- **Built-in help system**
Provides assistance for common problems. Available from the Help button on the projector or the remote control. See page 58 for details.
- **support.epson.com**
Download FAQs and e-mail your questions to EPSON support.
- **CD-ROM**
The EPSON PowerLite 503c/713c CD-ROM lets you register electronically and includes the electronic copy of this book as well as a link to *Presenters Online*.

note

You don't need to install any software to use your projector.

If you still need help after checking this *User's Guide* and the sources listed above, you can use the EPSON PrivateLine Support service to get help fast. Call (800) 637-7661 and enter the PIN on the card in your *Owner's Kit*.

Registration and Warranty

Your projector comes with a basic carry-in warranty and an international warranty that let you project with confidence anywhere in the world. For details, see page 86 and the warranty brochure included in your *Owner's Kit*.

In addition, for customers who register their projectors, EPSON offers free Extra CareSM Road Service. In the unlikely event of an equipment failure, you won't have to wait for your unit to be repaired. Instead, EPSON will ship you a replacement unit anywhere in the United States or Canada, usually via overnight delivery. See the brochure in your *Owner's Kit* for details.

To register, simply insert the PowerLite 503c/713c CD-ROM in your computer's CD-ROM or DVD drive and select **Register Online**. Registering also lets you receive special updates on new accessories, products, and services. You can register through the Internet, by e-mail or 800-number modem connection, or by printing out the form to fax or mail.

Unpacking the Projector

After unpacking the projector, make sure you have all the parts shown below:

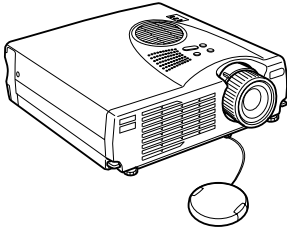

projector



remote control



EPSON PowerLite 503c/713c CD-ROM
(not needed to use your projector)



batteries

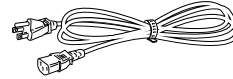

power cord

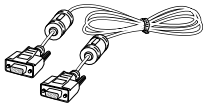

computer cable



RCA AV cable

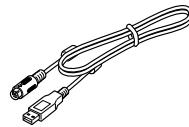

USB mouse cable

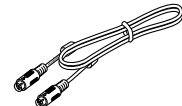

PS/2® mouse cable

Save all packaging in case you need to ship the projector. Always use the original packaging (or the equivalent) when you need to send the projector to another location.

If you are moving the projector by hand, use a carrying case (such as the optional cases available from EPSON). See page 8 for more information about cases.

Additional Components

Depending on how you plan to use the projector, you may need additional components:

- To receive an S-video signal, you need an S-video cable. (One is usually provided with your video device.)
- To amplify your computer's audio through the projector's sound system, you need a computer audio cable (male-to-male 3.5-mm stereo miniplug cable). See your computer or electronics dealer to obtain this cable.
- Some older PowerBooks and Macintosh desktop models may need the Macintosh adapter set shown on page 77 (available from EPSON; see page 8). Older iMac systems may need a special adapter to provide a VGA output port; see your computer dealer.
- Some systems may need an additional cable to use the remote control as a wireless mouse. If your Macintosh doesn't have a USB port, you'll need a Macintosh mouse cable. See your projector dealer to obtain the correct cable.

Optional Accessories

To enhance your use of the projector, EPSON provides the following optional accessories:

Product	Product number
Replacement lamp and air filter	ELPLP14
Soft carrying cases: Samsonite® wheeled soft case Slimline soft shoulder bag Notebook/projector soft shoulder bag ATA molded hard shell case	ELPKS35 ELPKS31 ELPKS32 ELPKS30
Ceiling mount	ELPMB32
Kensington® MicroSaver® security lock	ELPSL01
Portable projection screens: 50-inch screen 60-inch Insta-Theatre screen 80-inch Insta-Theatre screen	ELPSC06 ELPSC07 ELPSC08
Wireless microphone and two satellite speakers	ELPCVS1
Presentation audio system	ELPPAS1
Macintosh adapter set (includes monitor adapter and desktop adapter)	ELPAP01
VGA to 13W3 video cable (for connecting to certain high-end workstations)	ELPKC06

You can purchase these accessories from your dealer or by calling EPSON at (800) 873-7766; or visit the EPSON StoreSM at www.epson.com (U.S. sales only). In Canada, please call (800) 873-7766 for dealer referral.

1 *Setting Up the Projector*

This chapter tells you how to set up the projector and connect it to a laptop computer or video source. If you need to connect the projector to a desktop or workstation computer, see Appendix A.

You'll find instructions for the following in this chapter:

- Positioning the projector
- Connecting to a laptop computer
- Connecting to video sources

Positioning the Projector

Before connecting the projector, you need to decide where to place it. The location you choose depends on the size of the room and what you are projecting.

caution

Don't hold or lift the projector by the lens, or you may damage it.

note

It's easier to position the projector when the screen is directly in front of the room. If the screen is placed diagonally in a corner, it's much more difficult to aim the projector correctly at the screen and get a rectangular image.

- Place the projector on a sturdy, level surface, between 3.6 and 45.5 feet from the screen.
- Make sure there is plenty of space for ventilation around and under the projector.
- Make sure the projector is within 6 feet of a grounded electrical outlet or extension cord and within 5 feet of your computer and/or video source.
- Place the projector directly in front of the center of the screen, facing it toward the screen squarely. Otherwise, your image will not be rectangular.

Most presenters find it convenient to place the projector in front of the audience, leaving as much space as possible between the projector and the screen to get a good-sized image. This lets the presenter stand in the front of the room, face the audience, and remain close enough to the equipment to be able to control it.

Use the figure below as a guideline to help you determine how far from the screen to place the projector. Image size generally increases with distance, but may vary depending on how you position the lens ring and whether you have adjusted the image size with other settings.

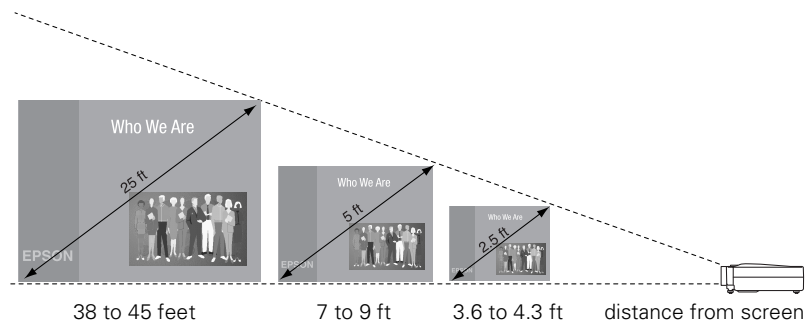

If you place the projector below the level of the screen, you'll have to tilt it up by extending the feet as shown. Tilting the projector upward causes the image to lose its rectangular shape, but you can correct the distortion by pressing the **Keystone** button as described in the next chapter.

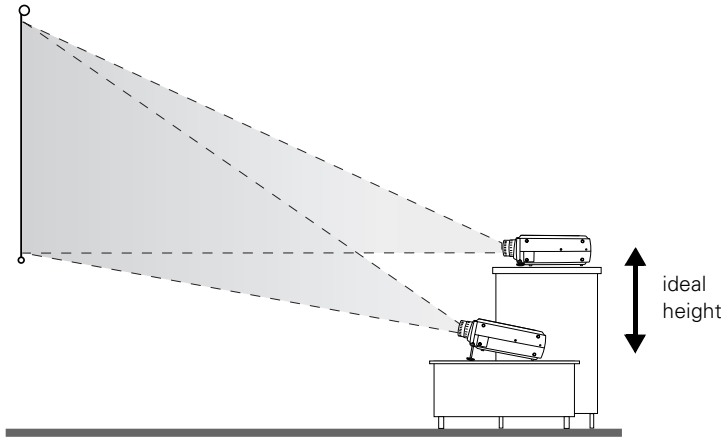

If you place the projector level with the bottom of the screen, the image will be rectangular and you won't have to adjust it. If you place the projector higher than the bottom of the screen, the image will still be rectangular, but you won't be able to fill the whole screen with the image.

note

After positioning the projector, you may want to connect a Kensington MicroSaver anti-theft device to the lock port on the projector's left side. You can purchase this from EPSON; see page 8.

Connecting to a Laptop Computer

note

To connect to desktops and other computer systems, see Appendix A. If you have an iBook with an RCA video-out port, follow the instructions for connecting to a video device on page 15.

You can connect the PowerLite projector to any computer that has a standard video output (monitor) port, including PC notebook and laptop computers, Macintosh PowerBooks, and hand-held devices.

Connecting the Computer Cable

Before you start, make sure your computer and the projector are turned off.

1. Connect one end of the computer cable to the projector's Computer port.

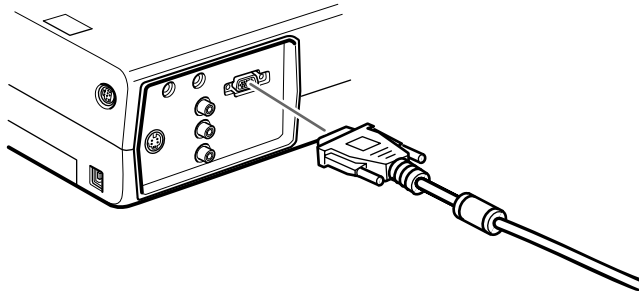

2. Connect the other end of the computer cable to your laptop's video-out or monitor port.

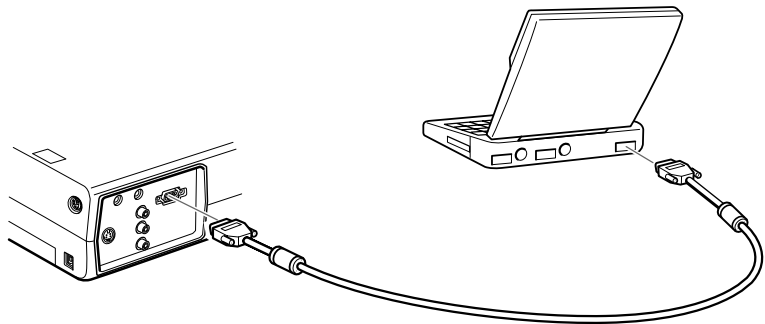

note

Laptop configurations vary. See your computer manual for the location of the ports needed to connect your projector.

If you're using a PowerBook and you can't connect the cable, you may need to use the Macintosh desktop adapter as shown on page 77 (available from EPSON; see page 8).

3. Tighten the screws on the connectors.

If you don't need to make any other connections, you can plug in your projector and turn it on. See page 18 for instructions.

Connecting the Cable for Remote Mouse Control

Using the remote control as a wireless mouse lets you click through slideshow-style presentations, such as PowerPoint, from up to 30 feet away (for details, see page 36). This gives you more flexibility in delivering your presentation, since you won't need to stand near your computer.

You'll use different cables and different ports on the projector, depending on whether your laptop has a round mouse port or a flat USB mouse port.

note

If you're using a PowerBook that has a round mouse port, you'll need a Macintosh mouse cable. See your projector dealer to obtain the correct cable.

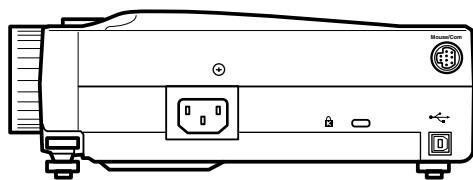

Mouse/Com port

USB port

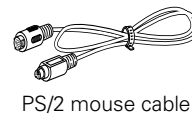

PS/2 mouse cable

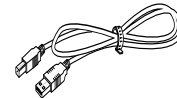

USB mouse cable

1. Locate the cable you need, depending on whether your laptop has a round PS/2 mouse port or a flat USB port.
2. Connect one end of the appropriate mouse cable to the projector's Mouse/Com or USB port, as shown.

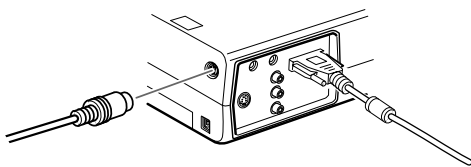

connecting PS/2 mouse cable

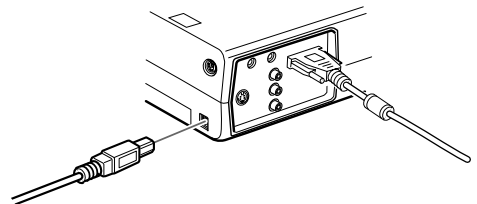

connecting USB mouse cable

3. Connect the other end of the cable to the external mouse port or USB port on your laptop.

4. If necessary, configure your laptop to work with an external mouse.



If you don't need to make any other connections, you can plug in your projector and turn it on. See page 18 for instructions.

Amplifying Computer Audio

Your laptop probably has its own sound system; however, it may not be adequate for your presentation. If you need more volume or better sound quality, you can connect a computer audio cable to take advantage of the projector's built-in amplifier and speaker. You can obtain a computer audio cable (3.5-mm stereo miniplug cable) from a computer or electronics dealer.

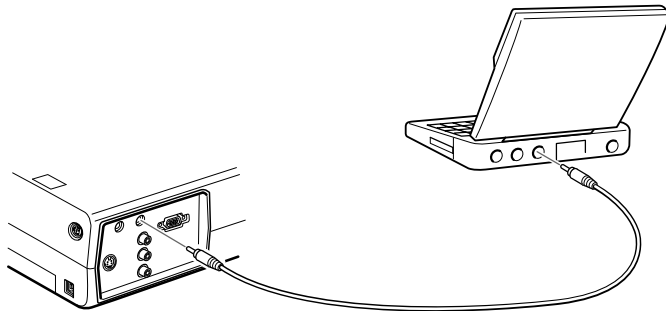
1. Connect one end of the audio cable to the **Audio In** jack on the projector.



2. Connect the other end of the audio cable to your laptop's  headphone jack or  audio-out jack. (Jack locations vary; see your computer manual if you're not sure which jack to use.)

If you don't need to make any other connections, you can plug in your projector and turn it on. See page 18 for instructions.

Connecting to Video Sources

You can connect a DVD player, VCR, camcorder, laser disc player, digital camera, or any other compatible video source to your projector.

The projector supports NTSC, PAL, and SECAM, and automatically detects the video format.

A standard RCA A/V cable is included with the projector. If your video source also has an S-video jack (as shown with an S-video plug at the right), you can use it to provide a higher quality video image. However, you'll need an S-video cable, which may be included with your video source, or may be purchased from an electronics store or video dealer.



note

The projector does not support TV antenna cable F connectors.

Follow the instructions below for your type of connection.

Connecting the RCA A/V Cable

Before starting, make sure the projector and your DVD player or other video source are turned off.

1. Connect the yellow plug on one end of the A/V cable to the projector's **Video** jack. Then connect the audio plugs to the left and right **Audio** jacks (insert the white plug into the L port and the red plug into the R port).

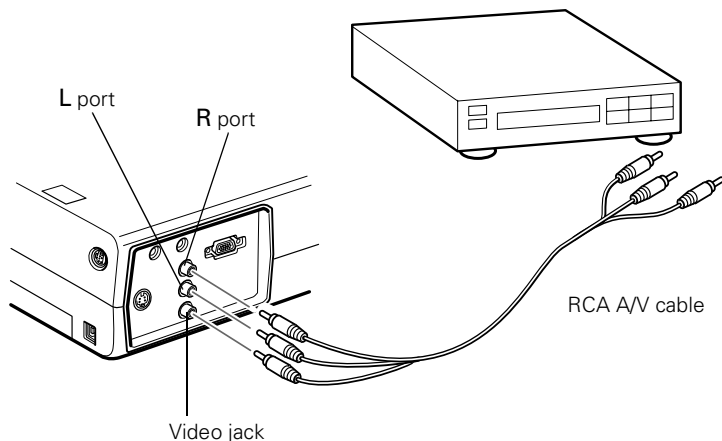

2. Connect the plugs on the other end of the cable to the video-out and audio output jacks on your video source.

Connecting S-Video

If your video source has an S-video jack, you can use it to project a higher quality video image. However, you'll need an S-video cable, which may be included with your video source, or may be purchased.

Before starting, make sure the projector and your DVD player or other video source are turned off.

1. Insert one end of an S-video cable into the projector's **S-Video** connector.
2. Insert the other end into the S-video output port of your video source.

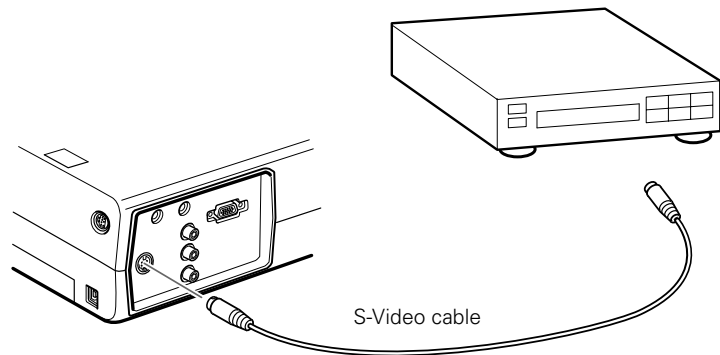

3. Connect the RCA A/V cable to the left and right **Audio** jacks on the projector. (Match the red and white plugs to the red and white jacks; you won't need to use the yellow plug.)
4. Connect the plugs at the other end of the cable to the audio output jacks on your video source.

2

Using the Projector

Once you've set up the projector, you're ready to turn it on, adjust the image, and give your presentation.

Although you can operate the projector without it, the remote control lets you use additional features. See Chapter 3 for instructions on using the remote. This chapter covers the following:

- Turning on the projector and other equipment
- Adjusting the image
- Shutting down the projector

Turning On Your Equipment

Make sure your projector and other equipment are set up and connected correctly, as described in Chapter 1 or Appendix A. Then turn on your projector, as described below, followed by any equipment you've connected to it. You can turn on your computer and video equipment in any order, but if you have both a computer and video source connected, you may have to switch to the desired source as described on page 20.

Turning On the Projector

Follow these steps to plug in and turn on the projector:

1. Connect one end of the power cord to the projector's power inlet.

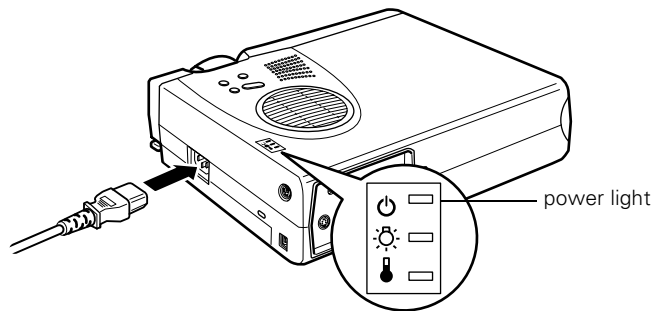

2. Connect the other end to a grounded electrical outlet.
The power light on top of the projector turns orange, indicating that the projector is receiving power but not yet turned on.
3. Use the tab on the lens ring to rotate the ring and extend the lens.

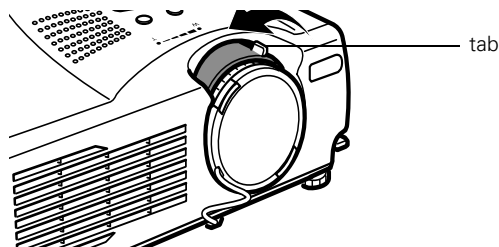

- Squeeze the lens cap tabs and remove the lens cap.

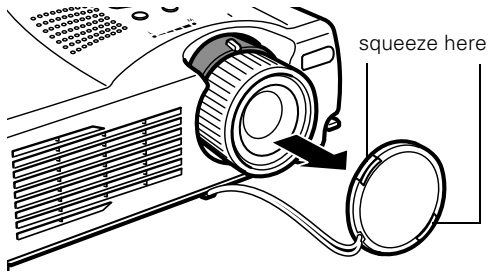

- Press the red Power button on top of the projector.

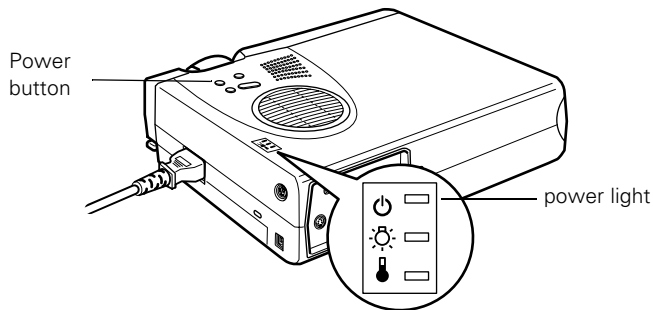

The power light flashes green as the projector warms up, and the projection lamp comes on in about 30 seconds. The power light stays green.

caution

Do not use the projector with the lens cap in place. The heat generated by the lens can damage the cap.

warning

Never look into the lens when the lamp is on. This can damage your eyes, and is especially dangerous for children.

6. Do one of the following:

- If you're using a computer, turn it on or restart it. In a few moments, you should see your computer display projected.

(Windows® only: If you see a message saying that it has found a plug-and-play monitor, click **Cancel**.)

- If you're projecting a video, press the **Source** button on top of the projector to switch to your video source, and press the **Play** button on your DVD player or other device.

If a projected image fails to appear, see the next section for help.

Once you see your image, turn to page 22 for instructions on focusing and making other image adjustments.

When you're done with your presentation, shut down the projector as described on page 25. Shutting down the projector correctly prevents premature lamp failure and possible damage from overheating.

What To Do If You See a Blank Screen

If you see a blank screen or a blue screen with the message **No Signal** after turning on your computer or video source, try the following:

- Make sure the cables are connected correctly, as described on page 12 (for laptops) or in Appendix A (for other systems).
- Make sure the power light is green and not flashing and the lens cover is off.
- Try restarting your computer.
- Press the **Source** button on top of the projector to select the correct source. (Allow a few seconds for the projector to sync up after pressing the button.)

If you're using a Macintosh Laptop:

You may need to set up your system to display on the projector screen as well as the LCD screen. Follow these steps:

1. From the Apple menu, select **Control Panels**, then click **Monitors** or **Monitors and Sound**.
2. Click the **Arrange** icon.

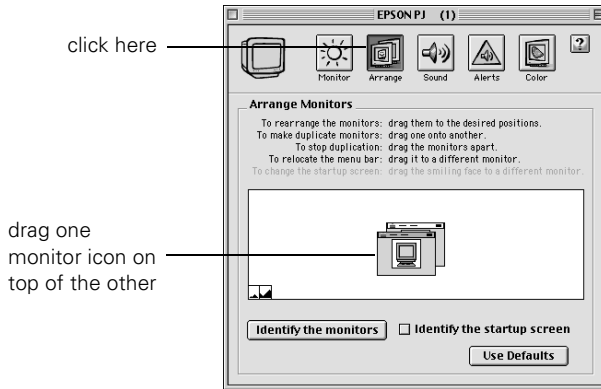

3. Drag one monitor icon on top of the other.

If the **Arrange** icon isn't available, you may need to select one of the Simulscan resolution settings:

1. Click the **Monitor** icon, if necessary.

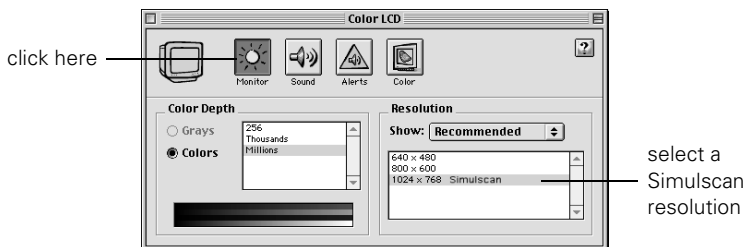

2. Select a **Simulscan** resolution as shown. (Allow a few seconds for the projector to sync up after making the selection.)

If you're using a PC laptop:

- Hold down the Fn key and press the function key that lets you display on an external monitor. It may have an icon such as  or it may be labelled CRT/LCD. Allow a few seconds for the projector to sync up after pressing it. Check your laptop's manual or online help for details.

On most systems, the  or CRT/LCD key lets you toggle between the LCD screen and the projector, or display on both at the same time.

- Depending on your computer's video card, you might need to use the Display utility in the Control Panel to make sure that both the LCD screen and external monitor port are enabled. See your computer's documentation or online help for details.

Adjusting the Image

Once you see your image, you'll need to make certain adjustments:

- To focus or zoom your image, see page 23.
- If the image is too high or too low, you can reposition it. See page 23.
- If the image isn't square, see page 24.

Focusing and Zooming Your Image

Rotate the focus ring to sharpen the image.

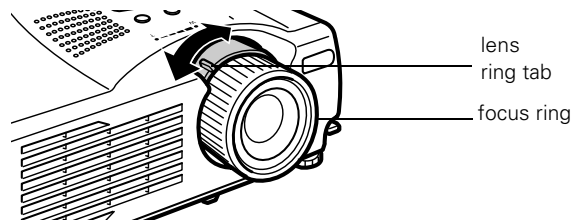

Use the tab to rotate the lens ring and reduce or enlarge the image.

You can also change the image size by moving the projector closer to or farther away from the screen. You can use the **E-ZOOM** button on the remote control to zoom in on a portion of the image. See page 31 for instructions.

Adjusting the Height of Your Image

If the image is too low, you can raise it by extending the projector's feet.

1. Stand behind the projector. Pull up the blue foot release levers and lift the front of the projector. This unlocks the feet.

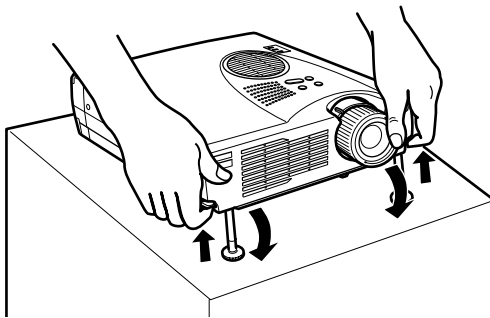

2. Once the image is positioned where you want it, release the levers to lock the feet in position.
3. To fine-tune the height of the image, rotate the thumb wheels attached to the projector's feet.





If the image is no longer rectangular after raising it, see the next section.

caution

Do not hold the projector by the lens; this can damage it.

Adjusting the Image Shape

If the projected image isn't rectangular or has a "keystone" shape, do one or more of the following:

- If your image looks like  or , you've placed the projector off to one side of the screen, at an angle. Move it directly in front of the center of the screen, facing the screen squarely.
- If your image looks like  or , press the + or — side of the **Keystone** button to correct the shape of the image. After correction, your image will be slightly smaller.

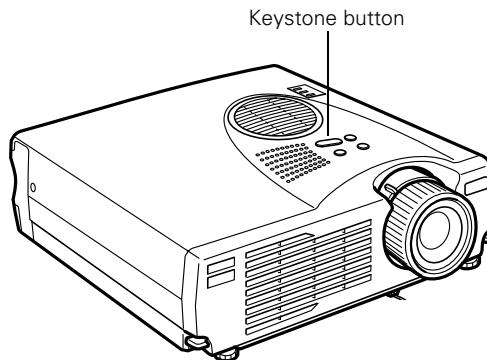

You can also perform electronic keystone correction using the projector's Setting menu. See page 46.

Shutting Down the Projector

When you've finished using the projector, follow the recommended procedure to shut it down. This extends the life of the lamp and protects the projector from possible overheating.

1. If you're using a computer, shut it down first.
2. To turn off the projector, press the red **Power** button on the projector or remote control. You see a confirmation message. (If you don't want to turn it off, press any other button.)

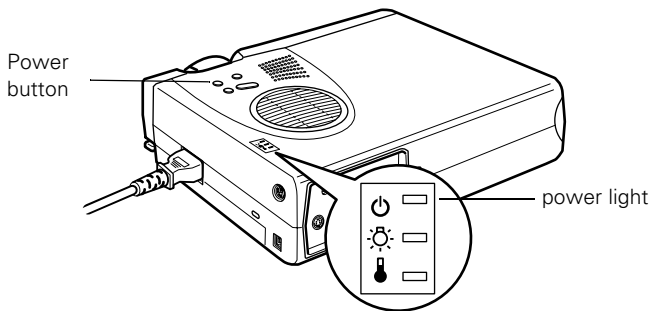

3. Press the **Power** button again. The power light flashes orange for about a minute as the projector cools down. When the projector has cooled, the orange light stays on and the exhaust fan shuts off.

If you want to turn the projector on again, wait until the orange light stops flashing. Then press the **Power** button.

4. Replace the lens cap, retract the lens, and unplug the power cord.
5. If you're using a VCR or other video source, turn it off after you turn off the projector.
6. Disconnect all equipment, and store the projector in the bag that came with it or in a protective case.

note

*When the projector has not received any input signals for 30 minutes, it automatically turns off the projector lamp and enters "sleep mode." This conserves electricity, cools the projector, and extends the life of the lamp. If you are done using the projector, unplug the power cord. If you want to start projecting again, press the **Power** button.*

caution

To avoid damaging the projector or lamp, never unplug the power cord when the power light is green or flashing orange.

3

Using the Remote Control

The remote control lets you access your projector's features from anywhere in the room—up to 30 feet away. You can use it to turn the projector on and off, zoom in on a portion of your image, and highlight your presentation.

If you're using a computer and you've connected the mouse cable (as described in Chapter 1 or Appendix A), you can use the remote control as a wireless mouse.

This chapter covers the following information:

- Turning on and using the remote control
- Controlling the picture and sound
- Highlighting your presentation
- Using the remote control as a wireless mouse

Turning On and Using the Remote Control

caution

When replacing batteries, take the following precautions:

- Don't mix old and new batteries.
- Replace batteries as soon as they run out. If the batteries leak, wipe away battery fluid with a soft cloth. If fluid gets on your hands, wash them immediately.
- Do not expose batteries to heat or flame.
- Dispose of used batteries according to local regulations.
- Remove batteries if you won't be using the projector for a long period of time.

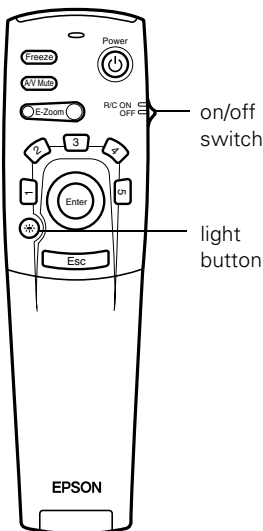

Before using the remote control, you need to install its batteries and turn it on as described below.

Installing Batteries

Follow these steps to install or replace the batteries:

1. Press the tab to release the battery compartment cover.
2. Remove the cover and insert the two AA batteries included with the projector as shown.
3. Replace the battery compartment cover.

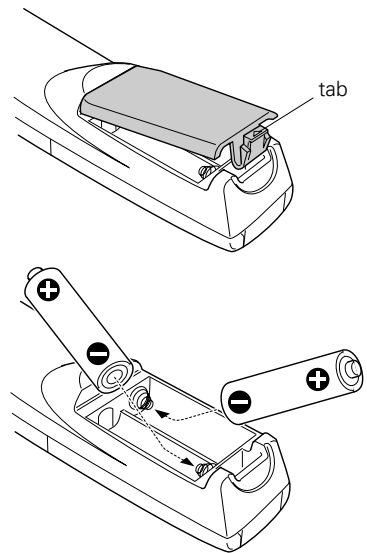

Turning On the Remote Control

Make sure batteries are installed. Then push up the on/off switch on the side of the remote control to turn it on.

If you want to make sure the batteries are good, press the round  light button. The other buttons on the remote should light up temporarily. If they don't, you need to change the batteries as described above.

Turn off the remote control before transporting it or storing it in a projector case. This prevents the batteries from discharging if something presses against one of the buttons.

Using the Remote Control

When using the remote control, stand within 30 feet of the projector. Point the remote control either at the front or back of the projector or at the screen (the projector's front sensor can detect signals bounced off the screen).

- Press the button for the function you want to use. See the following pages for instructions.
- For some functions, you need to use the **Enter** button like a mouse to navigate on the screen. Press the edge of the button with your thumb—or grasp it between your thumb and finger and tilt it in the direction you want to move.
- To access additional buttons, pull down the cover below the **Esc** button, as shown below:

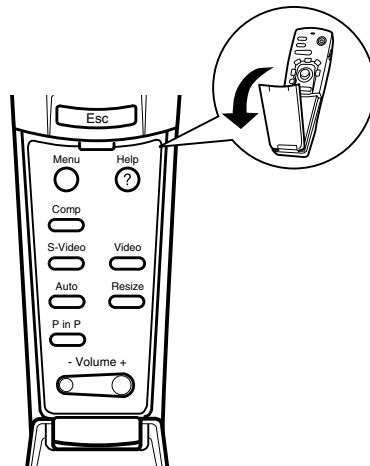

Controlling the Picture and Sound

You can use the remote control to select your source, adjust the volume, temporarily turn off the picture and sound, freeze the action, zoom in on the picture, or display a picture-in-picture video image. Make sure you have set up your projector and connected any equipment as described in Chapter 1 or Appendix A.

Switching Between Picture Sources

If you've connected your projector to a computer and a video source, you can use the buttons on the remote control to switch between the different sources.

- Press the **Comp** button to select your computer source.
- Press the **Video** button to select a standard composite video source.
- Press the **S-Video** button to select an S-video source.

After you select a source, the screen goes dark for a moment before the image appears.

Adjusting the Volume

If you've connected an audio source to the projector, you can adjust the sound that's output through the projector's speakers.

- To increase the volume, press on the right (+) side of the **Volume** button.
- To reduce the volume, press on the left (-) side of the **Volume** button.

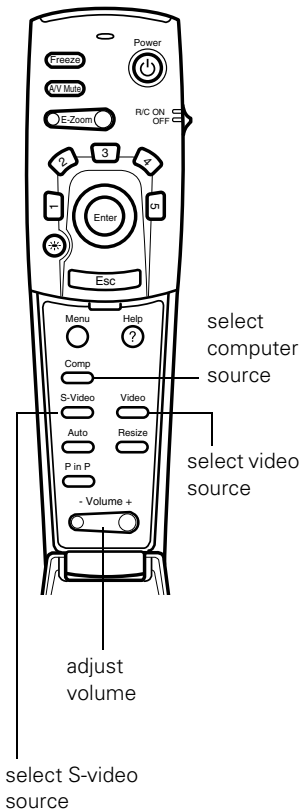

Turning Off the Picture and Sound

You can use the A/V Mute button on the remote control to turn off the image and sound and darken your screen. This is useful if you want to temporarily re-direct your audience's attention without the distraction of a bright screen.

- To turn off the picture, press the A/V Mute button. The screen goes dark.
- To turn the image back on, press the button again.

Stopping Action

You can use the remote control to stop the action in your video or computer image.

- Press the Freeze button to stop the action and keep the current image on the screen. The sound will continue.
- Press the Freeze button again to re-start it.

Zooming Your Image

You can zoom in on a portion of the image using the E-Zoom button on the remote control.

1. Press the right side of the E-Zoom button to zoom in on your image.
 - Press the button repeatedly to enlarge it up to four times in 12 steps.
 - Press and hold the button to zoom in to the size you want.
2. Use the Enter button to pan around the screen if necessary.
3. Press the left side of the E-Zoom button to zoom out. You can press the button repeatedly, or press and hold to zoom all the way out. You can also press the Resize button to return to the original size.

note

You can also have an image, such as a company logo, display on the screen whenever you press the A/V Mute button. See page 44 for instructions.

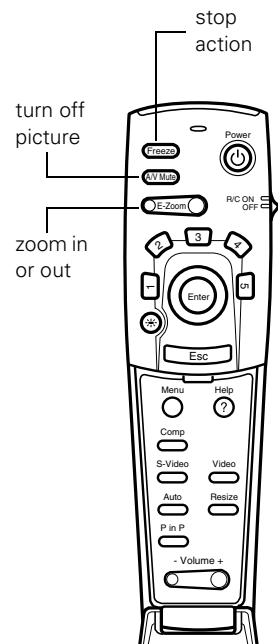

Resizing the Image

Some computer images need to be resized to display in the projector's native format—1024 × 768 pixels (PowerLite 713c) or 800 × 600 pixels (PowerLite 503c). If only part of your computer image is displayed, you can correct it with the **Resize** button.

- Press the **Resize** button on the remote control. The screen image is automatically compressed.
- Continue pressing the **Resize** button to pan around the screen image in the original resolution.

If you're projecting from video equipment, pressing the **Resize** button switches the aspect ratio between 4:3 and 16:9. If you've zoomed in on your image (using the **E-Zoom** button on the remote), you can press the **Resize** button to return it to the original display size.

Displaying Picture-in-Picture Video

You can open a small video window on your computer image, and view a video at the same time as your computer presentation.

First make sure you have connected your VCR or other video source using an RCA or S-video cable as described in Chapter 1. If you're using S-video, you need to select it in the **P in P** menu option as described on page 46.

1. Press the **P in P** button on the remote control. The screen may go dark for a moment, and then your video image appears in a small window on the screen. A menu appears in the lower left corner of the screen, describing how to move and resize the image.
2. Use the **Enter** button to reposition the video window on the screen. You can use the **E-Zoom** button to enlarge or reduce the video window.

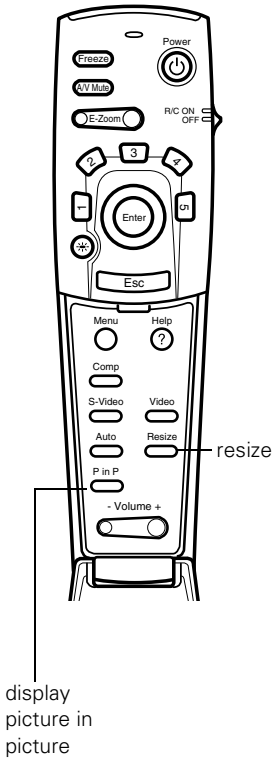

- When the window is located and sized the way you want, press the **Enter** button. The menu disappears, and your video plays on the screen.



- When you're finished viewing the picture-in-picture, press the **P in P** button again. The video window disappears.

Highlighting Your Presentation

You can highlight areas on the screen using the numbered buttons on the remote control. You can use these “special effects” features to annotate your presentation slides or call attention to your most important points. Five highlighting tools are available:

- Pointer or cursor stamp (button 1)
- Box (button 2)
- Straight line or marker (button 3)
- Freehand line (button 4)
- Erase (button 5)

You can customize the highlighting tools through the Effect menu. See page 43 for instructions.

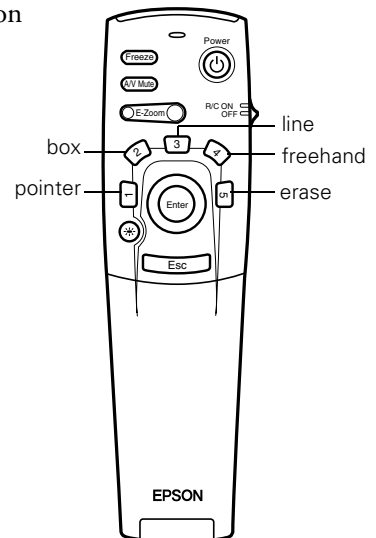

note

You can use the projector's Effect menu to select a different pointer. See page 43.

Using the Pointer

You can use the pointer tool to place an arrow anywhere on your screen.

1. To activate the pointer tool, press button 1 on the remote control. A yellow arrow appears in the upper left corner of the screen. 
2. Use the **Enter** button to move the arrow wherever you want it.
3. To “paste” the pointer on the screen, press down in the center of the **Enter** button. You can then continue to work with another pointer, moving it around the screen or pasting it wherever you want.
4. To erase the pointers pasted on the screen, press button 5.
5. To cancel the pointer feature, press **Esc**.

Using Box Highlights

You can draw outline boxes on the screen to highlight areas of your presentation or video.

1. To activate the box tool, press button 2 on the remote control. A  green square appears in the upper left corner of the screen. This is the box-drawing tool.
2. Use the **Enter** button to place the square where you want to begin drawing the box.
3. Press down in the center of the **Enter** button. You see a corner mark on the screen; this defines one corner of the box.
4. Use the **Enter** button to drag the square to where you want the opposite corner of the box to be.
5. Press down in the center of the **Enter** button. You see the box outlined on the screen.

You can continue placing boxes on the screen by repeating steps 2 through 5.

6. To erase the box(es), press button 5.
7. To cancel the box drawing feature, press **Esc**.

note

You can use the projector's Effect menu to change the color and shape of the box. See page 43.

Drawing Horizontal and Vertical Lines

You can draw horizontal or vertical lines on the screen to underline or highlight your presentation points.

1. To activate the line or marker tool, press the **3** button on the remote control. A pink marker icon appears in the upper left corner of the screen. This is the “line-drawing” tool. 
2. Use the **Enter** button to move the marker where you want to begin drawing the line.
3. To define the beginning of the line, press down in the center of the **Enter** button. You see a corner mark on the screen.
4. Use the **Enter** button to drag the marker where you want the line to end.
5. Press down in the center of the **Enter** button. You see a line on the screen, as shown at the right.



You can continue placing lines on the screen by repeating steps 2 through 5.

6. To erase the line(s), press the **5** button.
7. To cancel the line drawing feature, press **Esc**.

Drawing Freehand Lines

The freehand drawing tool lets you click and drag to draw opaque marks anywhere on the screen.

1. To activate the freehand tool, press the **4** button on the remote control. A pointing hand appears in the upper left corner of the screen. 
2. Use the **Enter** button to move the hand where you want to begin drawing.
3. Press down in the center of the **Enter** button to start your line and then press the edges of the **Enter** button to move around and draw.
4. To end a line or shape after drawing it, press down in the center of the **Enter** button.



note

You can use the projector's Effect menu to change the width and color for both “marker” and freehand lines. See page 43.

You can continue drawing on the screen by repeating steps 2 through 4.

5. To erase your drawing(s), press the **5** button.
6. To cancel the freehand drawing feature, press **Esc**.

Using the Remote Control as a Wireless Mouse

When you use the remote control as a wireless mouse, you can control your computer or click through slideshow-style presentations (such as PowerPoint) from up to 30 feet away. This gives you more flexibility, since you won't need to stand near your computer to change slides, for example.

To control your computer with the remote, make sure you have connected the mouse cable between the projector and your computer as described on page 13 (for laptops) or in Appendix A (for other systems).

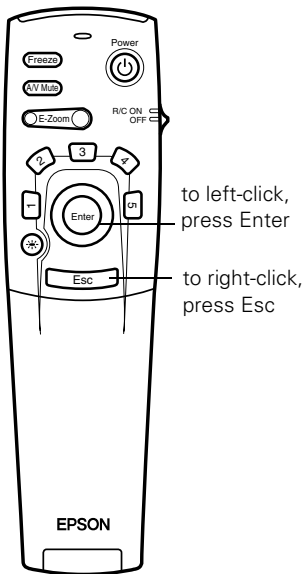

- To move the mouse pointer on the screen, aim the remote at the screen and press on the edge of the **Enter** button with your thumb—or grasp it between your thumb and finger and tilt it in the direction you want to move. This button works like the mouse button on many laptop keyboards.
- To click (or left-click), press down on the center of the **Enter** button. This changes slides in a PowerPoint presentation in Slide Show mode.
- To right-click, press the **Esc** button.
- To double-click, press down twice on the **Enter** button.
- To click and drag, press down on the **Enter** button and then tilt it in the direction you want to drag.

4

Fine-tuning the Projector

You can use the projector's on-screen menus to adjust the image, sound, and other features. You can also create your own startup screen, customize the highlighting tools, and find out how long your lamp has been in use. This chapter covers the following information:

- Using the menu system
- Adjusting the image
- Adjusting the sound
- Customizing the highlighting tools
- Creating your own startup screen
- Customizing projector features
- Viewing lamp usage and other information
- Restoring the default settings

Using the Projector's Menu System

The eight projector menus let you adjust and customize the projector features from the remote control:

- The Video menu controls the look and quality of the projected image. It lets you adjust the image position and fine-tune settings such as Brightness, Sharpness, and Contrast.
- The Audio menu controls the volume level, treble, and bass settings.
- The Effect menu lets you change the cursor speed and modify the highlighting tools available on the remote control.
- The Setting menu allows you to set or adjust features such as the Picture in Picture (P in P) video source, blank screen color, A/V Mute display option, and power management system.
- The User's Logo menu lets you capture and store a custom image or logo which you can then use as a startup screen or with the A/V Mute option.
- The Advanced menu lets you specify additional projector settings, including menu language, startup screen, color setting, and rear or ceiling projection.
- The About menu provides information about lamp status and computer or video settings.
- The Reset All menu lets you restore the factory defaults for all the projector settings.

Changing Menu Settings

You can use the buttons on the remote control to access the menus and change settings. Follow these steps:

1. To display the menu screen, press the **Menu** button on the remote control. You see the menu screen:

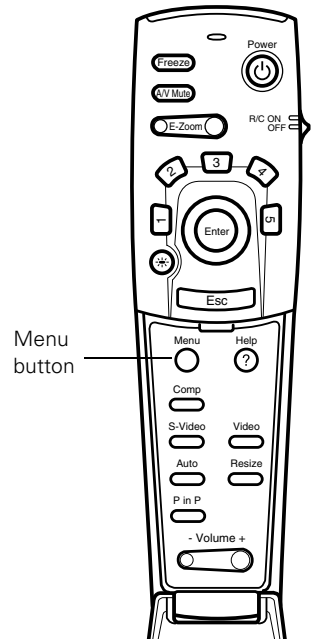
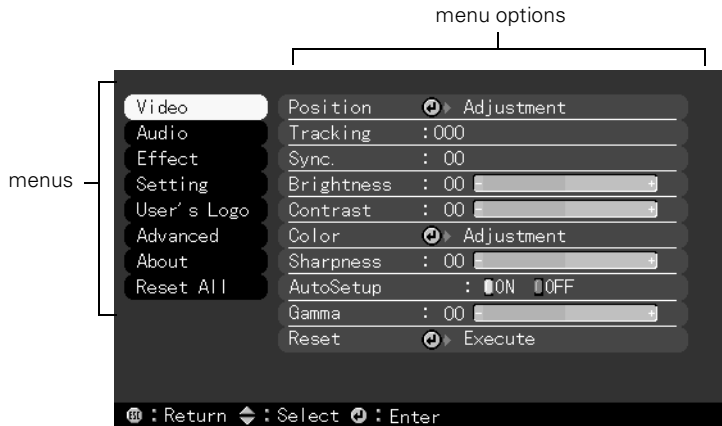

The eight menus are listed on the left, and the options available for the highlighted menu are shown on the right.

2. Press up or down on the **Enter** button to scroll through the menu list.
3. When the menu you want is highlighted, press the **Enter** button to select it. The highlight moves to the first option for that menu.
4. Use the **Enter** button to scroll through the list of options. (If a computer or video source isn't connected, certain options may be unavailable.)
5. Use the **Enter** button to change the setting for the selected option. Enabled settings have a green highlight.
6. Press the **Esc** button to return to the main menu. Your changes are saved automatically.
7. Press **Esc** again (or the **Menu** button) to exit the menu system.

note

*If you want to go back to the default settings on any menu, select **Reset**, press **Enter**, select **Yes**, and then press **Enter**.*

Adjusting the Image

The Video menu lets you make adjustments to the projected image. The options available in the menu depend on which image source is selected: computer or video.

note

*If you have repositioned the image, you can use the **Auto** button on the remote control to restore the default settings.*

Repositioning the Image

Follow these steps to fine-tune the image position:

1. Press the **Menu** button. You see the main menu.
2. Press **Enter** to select the Video menu.
3. Press **Enter** to select the **Position** option. You see the following on the right side of the screen:

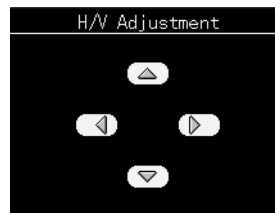

4. Use the **Enter** button to move the image left, right, up, or down.
5. When the image is positioned the way you want, press **Esc**.

Adjusting Image Appearance

Follow these steps to adjust the appearance of your image:

1. Press the **Menu** button. You see the main menu.
2. Press **Enter** to select the Video menu.
3. Use the **Enter** button to set one of the following options:
 - **Tracking (computer images only)**
Removes unwanted vertical lines from a computer image by matching the projector's internal clock to various computer signals.
 - **Sync (computer images only)**
Corrects fuzziness or screen flicker by synchronizing the projector with the tracking signal sent from the computer.
 - **Brightness**
Lightens or darkens the overall image.
 - **Contrast**
Adjusts the difference between light and dark areas.
 - **Color**
Adjusts the depth or intensity of the image. For computer images, lets you adjust individual red, green, and blue values.
 - **Tint (video only)**
Adjusts the balance of green to magenta in the image.
 - **Sharpness**
Sharpens or softens the image.
 - **Auto Setup**
Leave this setting **ON** to automatically optimize the computer image. Turn it off if you want to save adjustments you have made to the video settings.
 - **Gamma**
Adjusts overall brightness, contrast, and color balance.
4. When the image is set correctly, press **Esc** or **Menu**. Your settings are automatically saved.

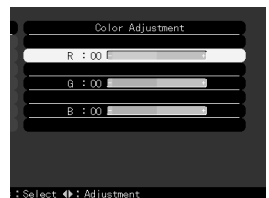

Adjusting the Sound

You can use the Audio menu to adjust the sound volume or treble/bass balance.

1. Press the **Menu** button. You see the main menu.
2. Use the **Enter** button to highlight **Audio**. You see the following:

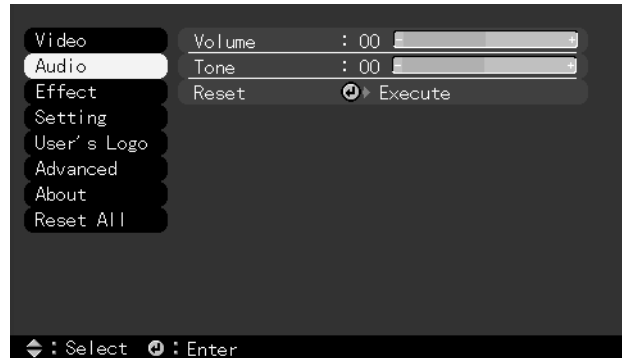

3. Press **Enter** to select the Audio menu.
4. Use the **Enter** button to set the following options:
 - Volume
 - Tone (treble/bass balance)
5. When you're finished adjusting the sound, press **Esc** or **Menu**.

Customizing the Highlighting Tools

The highlighting tools let you add pointers and other types of annotations to your image, as described on pages 33 to 36. You can use the Effect menu to customize these tools and set the cursor speed for highlighting. The **Reset** option lets you return all the highlighting tools to their default settings.

1. Press the **Menu** button. You see the main menu.
2. Use the **Enter** button to highlight **Effect**. You see the Effect menu:



3. Press **Enter** to select the **Effect** menu.
4. Use the **Enter** button to customize:
 - **Cursor/Stamp**
Lets you define a new pointer and set the size (zoom rate).
 - **Box**
Lets you define the box color and choose from rounded or square corners.
 - **Marker**
Lets you choose the color and width of the line.
 - **Freehand**
Lets you choose the color and width of the freehand line.
 - **Cursor Speed**
Lets you choose low, medium, or high speed for highlighting.

5. Use the **Enter** button to make your selections.
6. When you're finished customizing the highlighting tools, press **Esc** or **Menu**. Your selection(s) are saved.

Creating Your Own Startup Screen

You can transfer any image on your computer to the projector, and then use it as the screen displayed when the projector is not receiving a signal. You can also set it to be displayed when you press the **A/V Mute** button, or as a startup screen. The image can be a company logo, slogan, photograph, or any other image you want to use.

Capturing the Image

Start by displaying the image you want to use on the projector. You can use an image from either a computer or video source such as a VCR or digital camera. Then follow these steps to capture the image and transfer it to the projector:

1. Press the **Menu** button on the remote control. You see the main menu.
2. Use the **Enter** button to highlight the **User's Logo** menu.



3. Press **Enter** to select it. You see the message shown at the left.
4. Select **Yes** and press **Enter**. A selection box displays over the image.

5. Click and drag using the **Enter** button to select the area of the image you want to use. Once you have selected the entire area, press **Enter**.
6. When you see the message “Do you use this image?” select **Yes** and press **Enter**. If you want to change the area selected, select **No**, press **Enter** and repeat steps 4 through 6. You see a message like the one at the right.
7. Use the **Enter** button on the remote control to select a zoom rate (display size), and then press **Enter**.
8. When you see the message “Do you save the user logo?,” select **Yes** and press **Enter**. Saving the logo may take a few minutes. Do not use the projector or other sources (computer, video, speaker, etc.) while the logo is being saved.
9. When you see the message “Saving the user logo is completed,” press **Esc** or **Menu**.



Selecting When the Image Displays

After your image is saved, you can set it up as the no-signal message and/or the screen that’s displayed when you press the **A/V Mute** button.

1. Press the **Menu** button to display the main menu (if not already displayed).
2. Use the **Enter** button to highlight **Setting**.
3. Press **Enter** to select the Setting menu.
4. Use the **Enter** button to highlight **No-Signal Msg**.
5. Use the **Enter** button to select **Logo**. This sets your image as the screen displayed when the projector is not receiving a signal.
6. If you want to set up your image as the **A/V Mute** display, use the **Enter** button to move down to **A/V Mute**.
7. Use the **Enter** button to select **Logo**. This sets your image as the screen displayed when you press the **A/V Mute** button.
8. When you’re finished, press **Esc** or **Menu**.

note

You can also set up your image as a startup screen. Use the Advanced menu to enable the startup screen; see page 48.

To test your setting, press the **A/V Mute** button to display your image. Press it again to turn off the image.

Customizing Projector Features

You can use the Setting menu to enable the projector's power management system, adjust the image shape, and customize several other features.

1. Press the **Menu** button.
2. Use the **Enter** button to highlight **Setting**. You see the features and their settings on the right side:

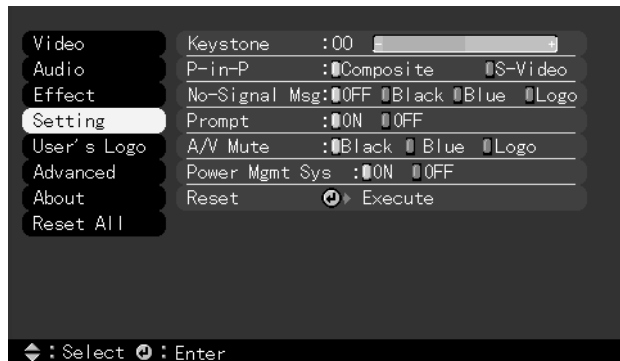

3. Press **Enter** to select the Setting menu.
4. Use the **Enter** button to set the following options:
 - **Keystone**
Adjusts a distorted image from a trapezoid shape to rectangular.
 - **P in P**
Changes from a composite (standard) video source to an S-video source for the picture-in-picture display.

- **No-Signal Msg.**
Selects the screen color and message to display when the projector is not receiving a signal. The logo setting displays an image that you have transferred to the projector. See page 44 for instructions on transferring an image to use as the no-signal message.
 - **Prompt**
Turns off the identifying text that appears briefly when you switch from computer input to a video source.
 - **A/V Mute**
Selects the screen color or image to display when you press the **A/V Mute** button. The logo setting displays an image that you have transferred to the projector. See page 44 for instructions on transferring an image to use for the A/V Mute display.
 - **Power Mgmt Sys**
Enables or disables the power management system, which turns the lamp off when the projector has not received any input signals for 30 minutes.
5. When you're finished, press **Esc** or **Menu**.

Setting Advanced Features

You can use the Advanced menu to configure the projector for rear projection or ceiling mounting, and adjust several other features.

1. Press the Menu button.
2. Use the Enter button to highlight **Advanced**. You see the features and their settings on the right side:



3. Press Enter to select the Advanced menu.
4. Use the Enter button to set the following options:
 - **Language**
Select from nine languages to be used for the projector menus.
 - **Startup Screen**
Turn on to display the image or logo you have captured whenever the projector starts. See page 44 for more information.
 - **Color Temp**
Adjusts the whiteness of the screen. Positive color temperature values provide a cold white; negative values provide a warmer white.
 - **Rear Proj.**
Turn on to project from behind onto a transparent screen.

■ Ceiling

Turn on when the projector is mounted upside-down from the ceiling.

5. When you're finished, press **Esc** or **Menu**.

Viewing Lamp Usage and Other Information

Use the About menu to view information about the display settings of your computer and the number of hours the lamp has been used.

1. Press the **Menu** button. You see the main menu.
2. Use the **Enter** button to select **About**.

You see the lamp usage hours and computer display settings on the right:

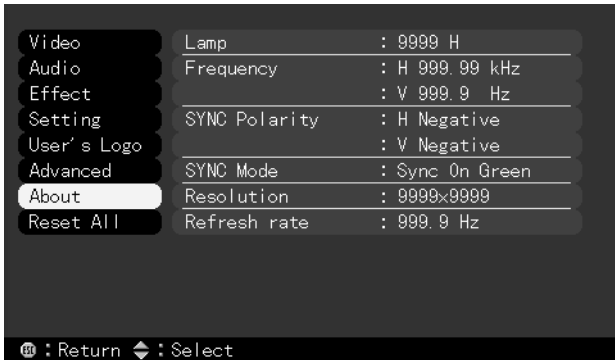

The life span of the lamp is about 1000 hours. If the number shown is close to 1000, make sure you have a spare lamp handy.

3. When you're finished, press **Esc** or **Menu**.

note

If you access the About menu when the projector display is set to video, you only see the lamp life and the video signal setting.

Restoring the Default Settings

The Reset All option lets you return all the projector settings to their default values.

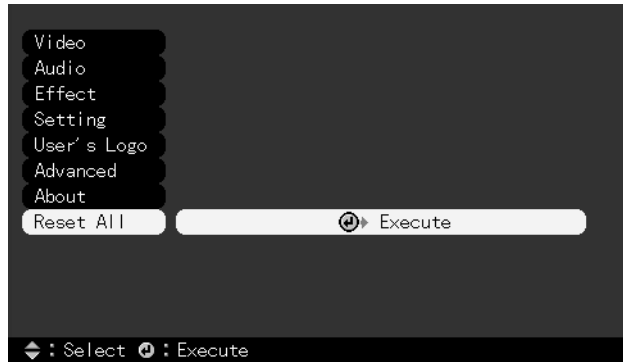

Select **Reset All** and press the Enter button on the remote control to display the confirmation screen. Select **Yes** to reset all the default settings or **No** to cancel.

5 *Maintaining and Transporting the Projector*

warning

Before you clean any part of the projector, turn it off and unplug the power cord. Never open any cover on the projector, except the lamp and filter covers. Dangerous electrical voltages in the projector can injure you severely. Do not try to service this product yourself, except as specifically explained in this User's Guide. Refer all other servicing to qualified service personnel.

Your projector needs little maintenance. All you need to do on a regular basis is keep the lens clean. Any dirt or smears on the lens may show up on your projected image.

You also need to periodically clean the air filter on top of the projector. A clogged air filter can block ventilation needed to cool the projector and keep it from overheating.

The only parts you should replace are the lamp and air filter. If any other part needs replacing, contact your dealer or a qualified servicer.

This chapter covers the following:

- Cleaning the lens
- Cleaning the projector case
- Cleaning and replacing the air filter
- Replacing the lamp
- Transporting the projector

Cleaning the Lens

Clean the lens whenever you notice dirt or dust on the surface.

- Use a canister of compressed air to remove dust.
- To remove dirt or smears on the lens, use lens-cleaning paper. If necessary, moisten a soft cloth with lens cleaner and gently wipe the lens surface.

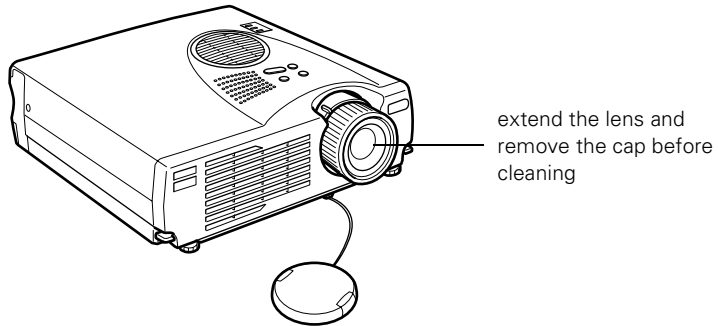

Cleaning the Projector Case

Before you clean the case, first turn off the projector and unplug the power cord.

- To remove dirt or dust, wipe the case with a soft, dry, lint-free cloth.
- To remove stubborn dirt or stains, moisten a soft cloth with water and a neutral detergent. Then wipe the case.
- Do not use wax, alcohol, benzene, thinner, or other chemical detergents. These can damage the case.

Cleaning and Replacing the Air Filter

Clean the air filter on top of the projector after every 100 hours of use. If it is not cleaned periodically, it can become clogged with dust, preventing proper ventilation. This can cause overheating and damage the projector. To clean the air filter, follow these steps:

1. Turn off the projector, allow it to cool down, and unplug the power cord.
2. Stand the projector on end to keep dust and dirt from falling inside.
3. To clean the filter, EPSON recommends using a small vacuum cleaner designed for computers and other office equipment. If you don't have one, gently clean the filter using a very soft brush (such as an artist's camel-hair brush).

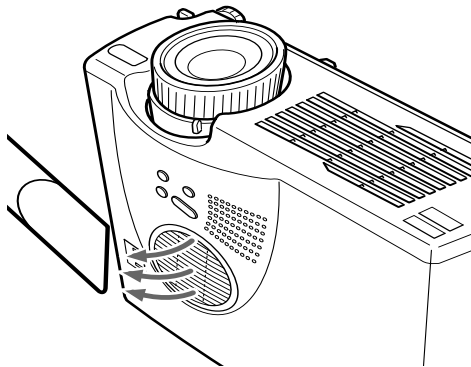

If the dirt is difficult to remove or if the filter is torn, replace it. Contact your dealer or call EPSON at (800) 873-7766 in the United States and Canada to obtain a new one.

note

When you get a replacement lamp for your projector, a new air filter is included. You should replace the filter when you replace the lamp.

4. If you need to replace the filter, use a small screwdriver to pry it off.

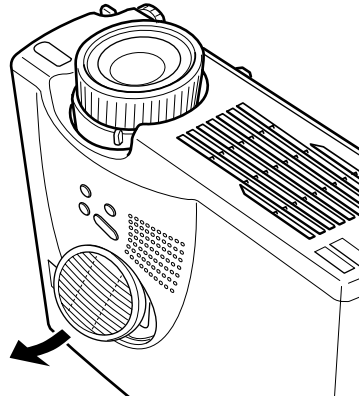

5. To install the new filter, first insert the tab, then press down until it clicks in place.

Replacing the Lamp

note

You can check to see how many hours the lamp has been used. See page 49.

The projection lamp typically lasts for about 1000 hours of use. It is time to replace the lamp when:

- The projected image gets darker or starts to deteriorate.
- The  lamp warning light is red, flashing red, or flashing orange.
- The message **LAMP REPLACE** appears on the screen when the lamp comes on (after about 900 hours of use). To maintain projector brightness and image quality, replace the lamp as soon as possible.

Contact your dealer or call EPSON at (800) 873-7766 in the United States and Canada for a replacement lamp. Request part number ELPLP14.

Follow these steps to replace the lamp:

1. Turn off the projector, then unplug the power cord.
2. Allow the projector to cool down for at least half an hour (if it has been on).
3. Turn the projector upside-down to access the lamp compartment.
4. Use a screwdriver to loosen the retaining screw on the lamp cover. (You can't remove the screw from the cover.)

When the screw is loose, lift off the lamp cover.

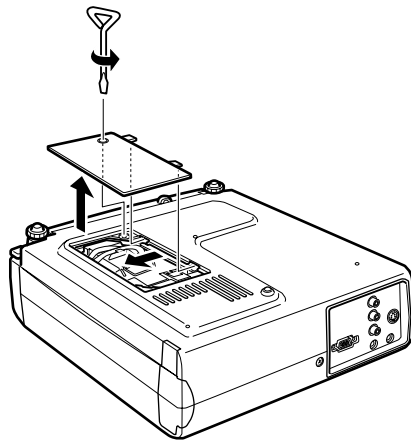

5. Use a screwdriver to loosen the two screws holding the lamp in place. (You can't remove these screws.)
6. Lift up the wire handle, as shown, and pull the lamp straight out.

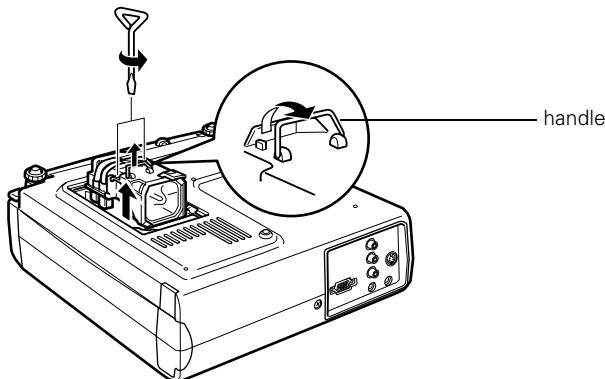

warning

Let the lamp cool before replacing it. If the lamp breaks, handle the shards carefully to avoid injury.

caution

Do not touch the glass portion of the lamp assembly. Touching the glass could result in premature lamp failure.

7. Gently insert the new lamp.
8. Once the lamp is fully inserted, tighten its screws.
9. Replace the lamp cover and tighten its screw securely. (The projector won't come on if the lamp cover is loose.)

Transporting the Projector

note

EPSON shall not be liable for any damages incurred during transportation.

The projector contains many glass and precision parts. If you need to transport it, please follow these packing guidelines to prevent damage to the projector:

- When shipping the projector for repairs, use the original packaging material if possible. If you do not have the original packaging, use equivalent materials, placing plenty of cushioning around the projector.
- When transporting the projector as freight or checked luggage, first put it in a carrying case (such as an optional EPSON case), then pack it in a firm box, using cushioning around the case.
- When you are hand-carrying the projector, be sure to use a carrying case (such as an optional EPSON case).
- If you want to store the remote control inside the projector's carrying case, be sure to turn it off using the switch on its side. This prevents the batteries from discharging if something presses against one of the buttons.

6

Solving Problems

This chapter helps you solve problems with your projector, and tells you how to contact technical support for problems you can't solve yourself. This chapter explains the following:

- Using the projector's on-screen help system
- What to do when the projector's status lights flash
- Solving problems with the image or sound
- Solving problems with the remote control
- Contacting technical support

Using On-Screen Help

If the image doesn't look right or your audio isn't working, you can get help by pressing the blue ? **Help** button on top of the projector or under the cover on the remote control. The following choices are available:

- Help for the image
- Help for the sound
- Language selection

Follow these steps to get help:

1. Press the blue ? **Help** button on the projector or the remote control. You see the help menu.
2. Press the left side of the **Select (Keystone)** button on the projector (or use the **Enter** button on the remote control) to highlight one of the options. Then press the **Enter (Source)** button to select it.
3. Press the left side of the **Select (Keystone)** button on the projector (or use the **Enter** button on the remote control) to highlight the problem you want to solve. Then press the **Enter (Source)** button to view the solution(s).
4. Highlight a solution (if this choice is available). Then press the **Enter (Source)** button to select the solution.

Highlight **Return** and press the **Enter (Source)** button if you need to back up.

If the solution is to adjust one of the settings, press the left side of the **Select (Keystone)** button on the projector (or use the **Enter** button on the remote control) to adjust it.

5. To exit the Help system, press the blue ? **Help** button.

If none of the suggestions solves your problem, see additional solutions to problems in the following sections.

What To Do When the Lights Flash

The lights on top of the projector indicate the projector's status and let you know when a problem occurs.

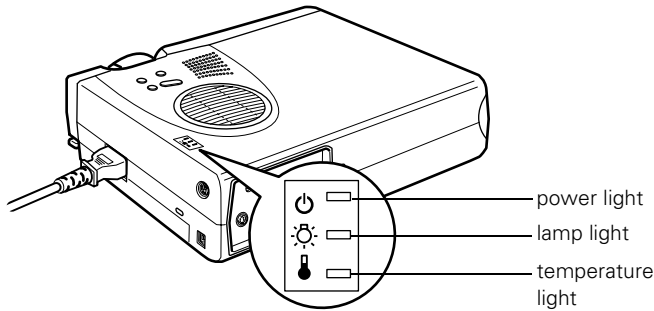

If the projector is not working correctly, first turn it off and unplug it. Then plug the power cord back in and turn on the projector. If this does not solve the problem, check the status lights on top of the projector and try the solutions recommended below.

The power light is flashing orange and you cannot turn on the projector.

The lamp is cooling down. Wait until the light turns off and then press the **Power** button to turn on the projector.

The power light does not come on.

Make sure the power cord is connected securely both at the power outlet and the projector. If you have just replaced the lamp, make sure the cover is securely fastened.

The lamp warning light is red or flashing orange.

Replace the lamp as described on page 54.

warning

Except as specifically explained in this User's Guide, do not attempt to service this product yourself.

The  temperature light is flashing orange.











- The projector is too hot. Make sure the room temperature does not exceed 104 °F and there is plenty of space around and under the projector for ventilation.
- The air filter may be clogged. Clean or replace it as described on page 53.

The  temperature light is red.

- The projector is overheating, which turns the lamp off automatically. Let the projector cool for a few minutes, then turn it back on. Make sure the room temperature is not above 104 °F and there is plenty of space around and under the projector for ventilation.
- The air filter may be clogged. Clean or replace it as described on page 53.
- If the projector continues to overheat after you clean the air filter, the problem may be caused by damage to the cooling fan or internal circuits. Contact EPSON for help.

Refer to the following table for a complete description of the projector's status lights and their meaning.

Status lights

Light	Status	Description
	orange	The projector is in sleep mode. You can unplug it or press the Power button to turn it on.
	flashing green	The projector is warming up. Wait for the image to appear.
	green	The projector is operating normally.
	flashing orange	The projector is cooling down. You can't turn it back on (and you should not unplug it) until the light stops flashing and remains orange.
	red	Power is cut off because of an internal problem. Remove the power cord and contact EPSON for help.
	red	The lamp is burned out. Replace it as described on page 54.
	flashing orange	The lamp is almost burned out. Replace it as described on page 54.
	flashing red	There is a problem with the lamp, power supply, fan, or circuit. If necessary, replace the lamp as described on page 54.
	flashing orange	The projector is too hot. Make sure the temperature surrounding the projector does not exceed 104 °F and there is plenty of space around and under the projector for ventilation. Clean the air filter, if necessary. See page 53 for instructions.
	red	The projector is overheating, which turns off the lamp automatically. Let it cool for a few minutes, then turn it back on. Make sure there is plenty of space around and under the projector for ventilation. If it continues to overheat, you may need to change the air filter. See page 53 for instructions.
	flashing red	There is a problem with the cooling fan or temperature sensor. Turn off the projector and unplug it. Contact EPSON for help.

Solving Problems with the Image or Sound

No image appears on the screen.

- Check that the power light is green, not flashing, and the lens cap is off.
- The projector may be in sleep mode. If the power light is orange, press the **Power** button to turn the projector on.
- If the power was switched off and then on again, the projector may still be cooling down. Wait until the power light stops flashing and remains orange; then press the **Power** button again.
- Make sure the **Brightness** setting on the Video menu is correct. See page 41 for more information. Try selecting the **Reset All** setting to return all setup menus to their default values.
- Press the **A/V Mute** button to make sure the picture has not been turned off temporarily.
- The attached computer may be in sleep mode or displaying a black screen saver. Try pressing a key on the computer.

You see a blue screen with the message No Signal displayed.

- Make sure the cables are connected correctly, as described in Chapter 1 or Appendix A.
- Try restarting your computer.
- If you've connected a computer and one or more video sources, you may need to press the **Source** button (on the projector) or the **Comp**, **Video**, or **S-Video** button (on the remote control) to select the correct source. Allow a few seconds for the projector to sync up after pressing the button.

If you're using a PC laptop:

- Hold down the Fn key and press the function key that lets you display on an external monitor. It may have an icon such as , or it may be labelled CRT/LCD. Allow a few seconds for the projector to sync up after pressing it. Check your laptop's manual or online help for details.

On most systems, the  or CRT/LCD key lets you toggle between the LCD screen and the projector, or display on both at the same time.

- Depending on your computer's video card, you might need to use the Display utility in the Control Panel to make sure that both the LCD screen and external monitor port are enabled. See your computer's documentation or online help for details.

If you're using a PowerBook:

1. From the Apple menu, select **Control Panels**, then click **Monitors** or **Monitors and Sound**.
2. Click the **Arrange** icon.
3. Drag one monitor icon on top of the other. This lets you display on the projector screen as well as the LCD screen.
4. If the **Arrange** icon isn't available, click the **Monitor** icon.
5. Select one of the listed **Simulscan** resolutions. (Allow a few seconds for the projector to sync up after making the selection.)

The message **Not Supported** is displayed.

Make sure your computer's resolution doesn't exceed UXGA (1600 × 1200, for the PowerLite 713c) or SXGA (1280 × 1024, for the PowerLite 503c), and the frequency is supported by the projector (see page 92). If necessary, change your computer's resolution setting as described on page 64.

Only part of the computer image is displayed.

- Press the **Resize** button on the remote control.
- Make sure the image **Position** setting is correct on the Video menu. See page 40 for more information.
- Make sure your computer's resolution setting is correct. Ideally, it should be 1024×768 to match the projector's native resolution (800×600 on the PowerLite 503c). If this option isn't available, select one of the other compatible video formats listed on page 92.
 - **Windows:**
Right-click the desktop, select **Properties**, click the **Settings** tab, and select a different resolution.
 - **Macintosh:**
On the Apple menu, choose **Control Panels**, then click **Monitors** or **Monitors and Sound**. Select a different resolution.
- You also may need to modify existing presentation files if you created them for a different resolution. See your software documentation for specific information.

The image isn't rectangular, but trapezoid-shaped.

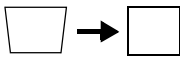
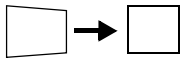

- Make sure the projector isn't placed off to one side of the screen, at an angle, or the image won't be rectangular. Place the projector directly in front of the center of the screen, facing the screen squarely.
- If you've tilted the projector upward by extending the legs, the image will be broader at the top. Hold down the + or - side of the **Keystone** button on top of the projector until the image is rectangular.

The image contains static or noise.

- If you're using a computer cable longer than 6 feet, or an extension cable, the image quality may be reduced.
- Keep your computer and video cables separated from the power cord as much as possible to prevent interference.
- The video signal may be split between the computer and the projector. If you notice a decline in the projected image quality when the image is displayed simultaneously on your laptop computer and the projector, turn off the laptop's LCD display.

The image is blurry.

- There may be dirt or smears on the lens. Clean the lens as described on page 52.
- Make sure the lens is fully extended.
- Adjust the focus using the focus ring.
- Make sure the lens is not fogged by condensation. You may need to wait before using the projector after moving it from a cold environment.
- Adjust the **Sharpness** setting on the Video menu (see page 41). When you change video settings, you should be able to see the effect on the screen immediately. If you're projecting from a computer, you may also need to adjust the Tracking and Sync as described in the next section. If you don't like the new settings, you can always select **Reset** to return to the factory default settings.

You see vertical stripes or the image still looks blurry after trying the solutions in the previous section.

- If you're projecting from a computer and displaying an image that contains a lot of fine detail, you may notice one or more vertical stripes or bands, or some of the characters may look heavy or blurred. Press the **Auto** button on the remote control. This resets the projector's tracking and sync settings.
- If further adjustment is needed, you can fine-tune the **Tracking** and **Sync** settings manually using the **Video** menu as described on page 41.
 1. Fill the screen with an image containing fine detail when making these adjustments. For example, in Windows you can select a pattern to appear as your desktop background. If this option isn't available, try projecting black text on a white background.
 2. Adjust the **Tracking** to eliminate vertical stripes.
 3. Adjust the **Sync** to increase the sharpness of the image.



The colors of the image are not right.

- If you're displaying a computer image, use the **Gamma** option in the projector's **Video** menu to adjust the color. If you're displaying video, adjust the **Color**, **Tint**, and **Gamma** settings on the **Video** menu.
- Try adjusting the **Color Temp** setting on the **Advanced** menu.
- Check your computer display settings to correct the color balance.

note

Because of the different technologies used, your projected image may not exactly match the colors on your laptop or computer monitor.

There is no sound.

- Try turning up the volume. Press the right side of the **Volume** button on the remote control.
- If you're using a VCR or other video source, make sure the volume is not turned all the way down or muted. Also, make sure the cables are connected correctly, as described in Chapter 1.
- If your presentation includes computer audio, make sure the volume control on your computer is not turned all the way down or muted. Make sure the audio cable is securely connected to both the projector and your computer's  headphone jack or  audio out jack. See page 14 (for laptops) or Appendix A (for other systems).
- Make sure the Windows volume controls on your computer are not turned all the way down or set to Mute. Check this by clicking the volume control in your Windows System Tray (lower right corner of the screen).
- Make sure the **A/V Mute** button is not enabled.
- The wrong source may be selected. Press the **Source** button on the projector—or the **Comp**, **Video**, or **S-Video** button on the remote control—to select the correct source.

Solving Problems with the Remote Control

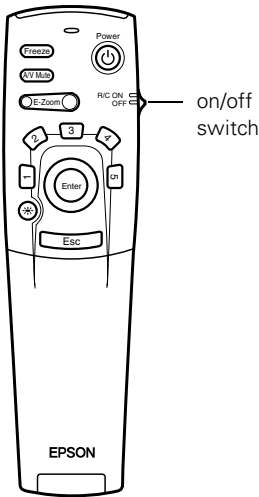

The projector doesn't respond to remote control commands.

- Make sure the remote control is turned on.
- Make sure you are within 30 feet of the projector, and within range of the projector's front or back sensor (approximately 30° to the left or right and 15° above or below).
- The remote control batteries may not be installed correctly or may be low on power. To test the batteries, press the ☀ light button. The other buttons on the remote should light up temporarily. If they don't, you need to change the batteries as described on page 28.
- Dim the room lights and turn off any fluorescents. Make sure the projector is not in direct sunlight. Strong lighting, especially fluorescent lights, may affect the projector's infrared receivers.
- Turn off any nearby equipment that emits infrared energy, such as a radiant room heater.

You can't control the mouse pointer with the remote control.

- Make sure the mouse cable is securely connected to both your computer's mouse port or USB port and the projector's mouse port. For details, see page 13 (for laptops) or Appendix A (for other systems).
- To use the USB mouse connection on a PC, your system must have a "clean" installation of Windows 98 (SR2), Windows Me, or Windows 2000. The connection may not work correctly if your system was upgraded from Windows 95. [TRUE?]

Where To Get Help

EPSON provides technical assistance through electronic support services 24 hours a day, as listed in the following table.

Service	Access
World Wide Web	From the Internet, you can reach EPSON's product support page at http://support.epson.com . After selecting your product, you can access troubleshooting information, download product documentation, and receive technical advice through e-mail.
Presenters Online	Access tips, templates, and training for developing successful presentations at http://www.presentersonline.com

Telephone Support Services

To use the EPSON PrivateLine Support service, call (800) 637-7661 and enter the PIN on the EPSON PrivateLine Support card included in your *Owner's Kit*. This is the fastest way of speaking to a live representative, and it's free. This service is available 6 AM to 6 PM, Pacific Time, Monday through Friday, for the duration of your warranty period.

You may also speak with a projector support specialist by dialing one of these numbers:

- U.S.: (562) 276-4394, 6 AM to 6 PM, Pacific Time, Monday through Friday
- Canada: (905) 709-3839, 6 AM to 6 PM, Pacific Time, Monday through Friday

Toll or long distance charges may apply.

Before you call, please have the following information ready:

- Product name (EPSON PowerLite 503c or EPSON PowerLite 713c)
- Product serial number (located on the bottom of the projector)
- Computer configuration
- Description of the problem

You can purchase screens, carrying cases, or other accessories from EPSON at (800) 873-7766 or by visiting the EPSON Store at www.epson.com (U.S. sales only). In Canada, please call (800) 873-7766 for dealer referral.

A

Appendix A: Connecting to Additional Equipment

This appendix explains how to connect the projector to a desktop computer or Macintosh, or a high-end workstation.

The following information is covered:

- Installing the projector
- Connecting to a PC desktop computer
- Connecting to a desktop Macintosh
- Connecting to a high-end workstation

Installing the Projector

The projector can be installed for three different viewing setups: front projection, ceiling mounting, or rear projection onto a semi-transparent screen.

To project from overhead, you'll need to select **Ceiling** in the projector's Advanced menu. To project from the rear, select **Rear Proj.** See page 48 for more information.

If you're ceiling-mounting the projector and you place it above screen level, you'll have to tilt it down to position the image on-screen. This causes the image to lose its rectangular shape. You can then correct the distortion by using the **Keystone** function in the projector's menu system (see page 46).

If you place the projector's lens so it's level with the top of the screen, the image will be rectangular and you won't have to adjust it. If you place the lens lower than the top of the screen, you'll have to tilt the projector upward if you want to fill the whole screen with the image.

Connecting to an External Audio System

The projector's internal speaker is loud enough for most rooms. However, if your installation requires maximum volume and sound quality, you can connect the projector to external speakers or a public address (PA) system. If you've connected a computer and video source, the projector will automatically switch the audio whenever you switch sources (see page 30).

To connect the projector to an external sound system, you will need an RCA-to-3.5 mm stereo audio cable, which may be included with your sound system, or may be purchased from an electronics store.

Before you start, make sure the projector and speakers or PA system are turned off.

1. Connect the cable's 3.5-mm stereo miniplug to the projector's **Audio Out** jack.

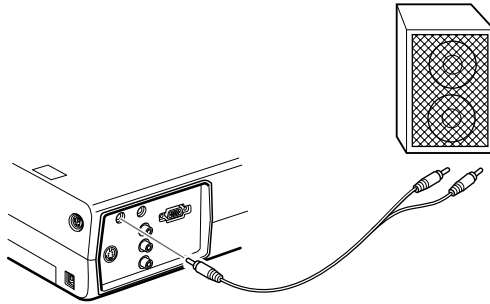

2. Connect the RCA plugs to the speaker or PA system. Insert the cable's red plug into the **Audio R** jack, and the white plug into the **Audio L** jack of the external speaker system.

Connecting to a PC Desktop Computer

You can connect the projector to any IBM compatible PC. This section includes instructions for the following:

- Connecting the computer cable
- Connecting the mouse cable (if you want to use the remote control as a mouse)
- Connecting an optional audio cable (if you'll be projecting with audio)

When you connect the projector to a desktop computer, you cannot view your display on the computer monitor.

Follow the steps in each section for the cables you need to connect. Before beginning, turn off the projector and computer if they are on.

Connecting the Computer Cable

1. Disconnect the monitor cable from the video port on the back of the computer.
2. Connect one end of the computer cable to the projector's Computer port.

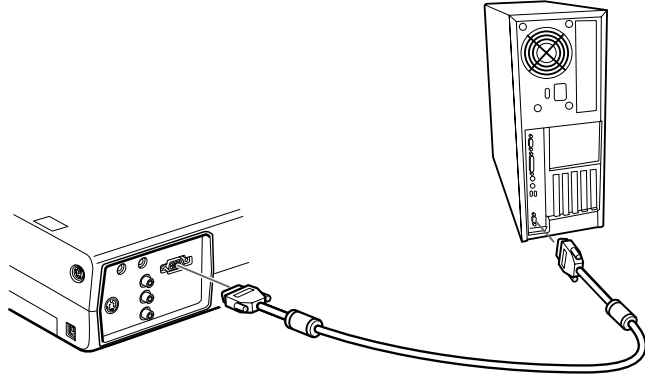

3. Connect the other end of the computer cable to the computer's video port.
4. Tighten the screws on the connectors.

Connecting the Mouse Cable

To use the remote control as a mouse, follow the steps below. You'll use a different mouse cable, depending on whether your computer has a round PS/2 mouse port or a flat USB port.

1. Connect one end of the appropriate mouse cable to the projector's **Mouse/Com** port or the USB port, as shown.

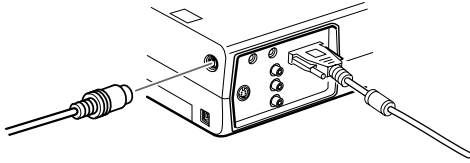

connecting PS/2 mouse cable

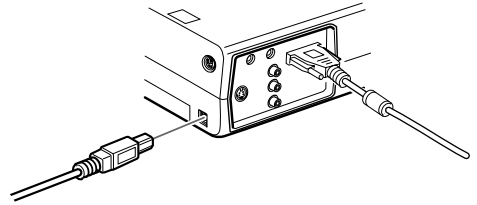

connecting USB mouse cable

2. Disconnect your mouse from the port on the back of your computer and replace it with the other end of the cable. (Your computer's mouse will be disabled while you are using the remote control as a mouse.)

Connecting the Audio Cable

If your presentation includes sound and you want to use the projector's built-in speakers, you can use a computer audio cable. The required cable (3.5-mm stereo miniplug cable) is available from computer or electronics dealers.

1. Connect one end of the audio cable to the **Audio In** jack on the projector.

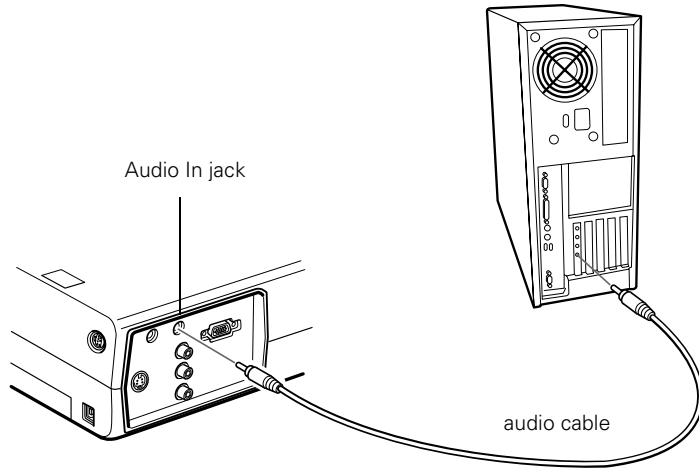

2. Connect the other end of the audio cable to the speaker or audio out port on the computer's sound card.

Connecting to a Desktop Macintosh

You can connect the projector to any desktop Macintosh. This section includes instructions for the following:

- Connecting the computer video cable
- Connecting the mouse cable (if you want to use your remote control as a mouse)
- Connecting an optional audio cable (if you'll be projecting with audio)

When you connect the projector to a desktop Macintosh, you cannot view your display on the Macintosh monitor.

Follow the steps in each section for the cables you need to connect. Before beginning, turn off the projector and computer if they are on.

Connecting the Computer Cable

Follow these steps to connect the computer cable. You may not need to use the adapter as shown.

1. Disconnect the monitor cable from the video port on the back of the Macintosh.
2. Connect one end of the computer cable to the projector's Computer port, as shown.

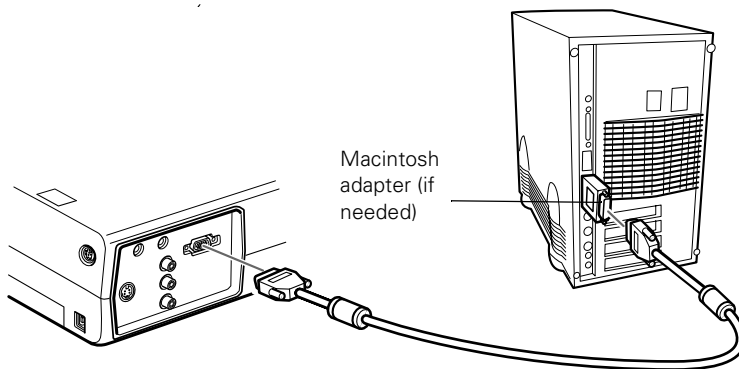

3. Connect the other end of the computer cable to the video port on the Macintosh.

note

Macintosh configurations vary. See your computer manual for the location of the ports needed to connect your projector. Older models may require a Macintosh adapter, which you may purchase from EPSON; see page 8.

If it doesn't fit, you may have to use a Macintosh desktop adapter, which you can buy from EPSON (see page 8).

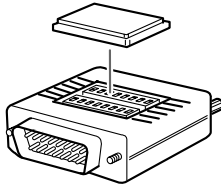

To use the adapter, remove its cover as shown and set its DIP switches according to the resolution you want to use, such as 16-inch mode. See your Macintosh documentation for instructions.

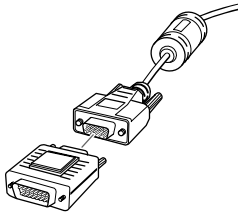

Replace the cover and connect the adapter to the free end of the computer video cable. Then plug the cable (with the adapter) into the video port on your Macintosh.

4. Tighten the screws on the connectors.

Connecting the Mouse Cable

To use the remote control as a mouse, follow the steps below.

If the Macintosh has a USB port, you can use the USB mouse cable that came with the projector. If it has a round mouse port, you'll need a Macintosh ADB mouse cable. See your projector dealer for help in obtaining the correct cable.

1. Connect one end of the mouse cable to the projector's USB port.

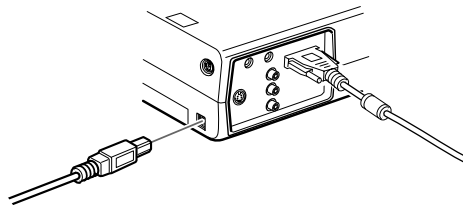

2. Disconnect your Macintosh's mouse cable. Connect the other end of the projector's mouse cable to a USB port on your Macintosh.

Connecting the Audio Cable

If your presentation includes sound and you want to use the projector's built-in speakers, you can use a computer audio cable. The required cable (3.5-mm stereo miniplug cable) is available from computer or electronics dealers.

1. Connect one end of the audio cable to the **Audio In** port on the projector.

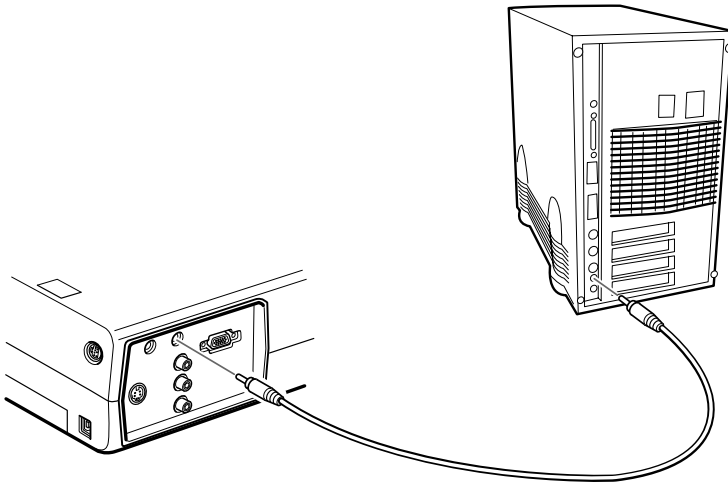

2. Connect the other end of the audio cable to the speaker or audio-out jack on the Macintosh.

Connecting to a High-End Workstation

Your PowerLite projector is capable of remapping input resolutions up to 1600×1200 pixels (1280×1024 pixels on the PowerLite 503c). Since 1280×1024 pixels is the default resolution for most leading workstations, your projector is ideal for displaying workstation video output.

There is no standard for workstation video output. Workstations that follow the SXGA standard and use the HD15 (standard VGA) connector won't need an adapter cable or any special connection device. However, your system may vary; contact your computer dealer if you need help connecting your workstation.

B

Appendix B: Notices

This appendix includes safety instructions and other important information about your EPSON PowerLite 503c/713c.

Important Safety Instructions

Follow these safety instructions when setting up and using the projector:

- Do not place the projector on an unstable cart, stand, or table.
- Do not use the projector near water or sources of heat.
- Use attachments only as recommended.
- Use the type of power source indicated on the projector. If you are not sure of the power available, consult your dealer or power company.
- Place the projector near a wall outlet where the plug can be easily unplugged.

Placez le projecteur près d'une prise de contact où la fiche peut être débranchée facilement.

- Insert the projector's three-wire grounding-type plug into a properly grounded outlet. If you have a two-prong outlet, contact an electrician to replace it. Do not hold the plug with wet hands.
- Take the following precautions for the plug. Failure to comply with these precautions could result in sparks or fire: Do not insert the plug into an outlet with dust present. Insert the plug firmly into the outlet.
- Do not overload wall outlets, extension cords, or integral convenience receptacles. This can cause fire or electric shock.

- Do not place the projector where the cord can be walked on. This may result in fraying or damage to the plug.
- Unplug the projector from the wall outlet before cleaning. Use a damp cloth for cleaning. Do not use liquid or aerosol cleaners.
- Do not block the slots and openings in the projector case. They provide ventilation and prevent the projector from overheating. Do not operate the projector on a sofa, rug, or other soft surface, or in a closed-in cabinet unless proper ventilation is provided.
- Never push objects of any kind through cabinet slots. Never spill liquid of any kind into the projector.
- Except as specifically explained in this *User's Guide*, do not attempt to service this product yourself. Refer all servicing to qualified service personnel. Opening or removing covers may expose you to dangerous voltages and other hazards.
- Unplug the projector during lightning storms or when it will not be used for extended periods.
- Do not place the projector and remote control on top of heat-producing equipment or in a hot location.
- Unplug the projector from the wall outlet and refer servicing to qualified service personnel under the following conditions: When the power cord or plug is damaged or frayed. If liquid has been spilled into the projector, or if it has been exposed to rain or water. If it does not operate normally when you follow the operating instructions, or if it exhibits a distinct change in performance, indicating a need for service. If it has been dropped or the housing has been damaged.
- If you use the projector in a country other than where you purchased it, use the correct power cord for that country.
- Do not stand on the projector or place heavy objects on it.
- Do not attempt to remove the lamp immediately after use. Allow the lamp to cool for approximately one hour before removing it.
- Do not use the projector outside of the required temperature range (41 to 95 °F). Doing so may cause an unstable display and an excessive load on the fan, leading to projector damage.

- Do not store the projector outside of the required temperature range (14 to 140 °F) or in direct sunlight for long periods of time. Doing so may cause damage to the case.
- Do not use the projector with the lens cap in place. The heat generated by the lens may damage the cap.
- The liquid crystal display panel contains more than 99.99% active pixels. However, 0.01% of the pixels may be missing or constantly illuminated.

Remote Control Information

You can operate the projector by remote control via a line-of-sight infrared (IR) receiver at the front and rear of the projector. The projector may not respond to remote control commands under the following conditions:

- There is an object between the remote control IR emitter and the IR receiver on the projector.
- Ambient light is too bright.
- Certain types of fluorescent lighting are used.
- A strong light source shines into the IR receiver.
- Other equipment that emits infrared energy, such as a radiant room heater, is in the room.

These conditions commonly cause problems for most infrared-controlled equipment. Try the following:

- The remote control unit's batteries may be low on power; replace them.
- Dim the ambient lighting and/or turn off any fluorescent lights.
- Close any window coverings and/or move the projector out of direct sunlight.
- Turn off other equipment that emits infrared energy.

If the remote control still does not work correctly, you can always run your computer-based presentation directly from the computer.

Declaration of Conformity

According to 47CFR, Part 2 and 15

Class B Personal Computers and Peripherals; and/or
CPU Boards and Power Supplies used with Class B
Personal Computers

We: EPSON AMERICA, INC.
Located at: 3840 Kilroy Airport Way
MS: 3-13
Long Beach, CA 90806
Tel: (562) 290-5254

Declare under sole responsibility that the product identified herein, complies with 47CFR Part 2 and 15 of the FCC rules as a Class B digital device. Each product marketed, is identical to the representative unit tested and found to be compliant with the standards. Records maintained continue to reflect the equipment being produced can be expected to be within the variation accepted, due to quantity production and testing on a statistical basis as required by 47CFR §2.909. Operation is subject to the following two conditions: (1) this device may not cause harmful interference, and (2) this device must accept any interference received, including interference that may cause undesired operation.

Trade Name: EPSON
Type of Product: LCD Projector
Model: EMP-713, ELP-503

FCC Compliance Statement

For United States Users

This equipment has been tested and found to comply with the limits for a Class B digital device, pursuant to Part 15 of the FCC Rules. These limits are designed to provide reasonable protection against harmful interference in a residential installation. This equipment generates, uses, and can radiate radio frequency energy and, if not installed and used in accordance with the instructions, may cause harmful interference to radio or television reception. However, there is no guarantee that interference will not occur in a particular installation. If this equipment does cause interference to radio and television reception, which can be determined by turning the equipment off and on, the user is encouraged to try to correct the interference by one or more of the following measures:

- Reorient or relocate the receiving antenna.
- Increase the separation between the equipment and receiver.
- Connect the equipment into an outlet on a circuit different from that to which the receiver is connected.
- Consult the dealer or an experienced radio/TV technician for help.

WARNING

The connection of a non-shielded equipment interface cable to this equipment will invalidate the FCC Certification of this device and may cause interference levels which exceed the limits established by the FCC for this equipment. It is the responsibility of the user to obtain and use a shielded equipment interface cable with this device. If this equipment has more than one interface connector, do not leave cables connected to unused interfaces. Changes or modifications not expressly approved by the manufacturer could void the user's authority to operate the equipment.

For Canadian Users

This Class B digital apparatus meets all requirements of the Canadian Interference-Causing Equipment Regulations.

Cet appareil numérique de la classe B respecte toutes les exigences du Règlement sur le matériel brouilleur du Canada.

Warranty

Epson America, Inc. Limited Warranty

Basic Two-Year Warranty and 90-Day Lamp Warranty

What Is Covered: Epson America, Inc. (“EPSON”) warrants to the first end user customer of the EPSON product enclosed with this limited warranty statement that the product, if purchased and used in the United States or Canada, conforms to the manufacturer’s specifications and will be free from defects in workmanship and materials for a period of two (2) years from the date of original purchase (except that the warranty period is 90 days for projector lamps).

What EPSON Will Do To Correct Problems: If you elect carry-in warranty service, please bring the product securely packaged in its original container or an equivalent, along with proof of the date of original purchase, to your EPSON Dealer or EPSON Customer Care Center. EPSON will, at its option, repair or replace on an exchange basis the defective unit, without charge for parts or labor. When warranty service involves the exchange of the product or of a part, the item replaced becomes EPSON property. The exchanged product or part may be new or previously repaired to the EPSON standard of quality. Exchange or replacement products or parts assume the remaining warranty period of the product covered by this limited warranty. However, each replacement lamp carries the limited 90-day warranty stated above.

What This Warranty Does Not Cover: This warranty covers only normal consumer use in the United States and Canada. For lamps, 24-hour-per-day use causes unusual strain and is not considered normal use. This warranty does not cover consumables (e.g., fuses), other than lamps. EPSON is not responsible for warranty service should the EPSON label or logo or the rating label or serial number be removed or should the product fail to be properly maintained or fail to function properly as a result of misuse, abuse, improper installation, neglect, improper shipping, damage caused by disasters such as fire, flood, and lightning, improper electrical current, software problems, interaction with non-EPSON products, or service other than by an EPSON Authorized Servicer. Postage, insurance, or shipping costs incurred in presenting your EPSON product for carry-in warranty service are your responsibility. If a claimed defect cannot be identified or reproduced in service, you will be held responsible for costs incurred.

THE WARRANTY AND REMEDY PROVIDED ABOVE ARE EXCLUSIVE AND IN LIEU OF ALL OTHER EXPRESS OR IMPLIED WARRANTIES INCLUDING, BUT NOT LIMITED TO, THE IMPLIED WARRANTIES OF MERCHANTABILITY OR FITNESS

FOR A PARTICULAR PURPOSE. SOME LAWS DO NOT ALLOW THE EXCLUSION OF IMPLIED WARRANTIES. IF THESE LAWS APPLY, THEN ALL EXPRESS AND IMPLIED WARRANTIES ARE LIMITED TO THE WARRANTY PERIOD IDENTIFIED ABOVE. UNLESS STATED HEREIN, ANY STATEMENTS OR REPRESENTATIONS MADE BY ANY OTHER PERSON OR FIRM ARE VOID. EXCEPT AS PROVIDED IN THIS WRITTEN WARRANTY, NEITHER EPSON AMERICA, INC. NOR ITS AFFILIATES SHALL BE LIABLE FOR ANY LOSS, INCONVENIENCE, OR DAMAGE, INCLUDING DIRECT, SPECIAL, INCIDENTAL OR CONSEQUENTIAL DAMAGES, RESULTING FROM THE USE OR INABILITY TO USE THE EPSON PRODUCT, WHETHER RESULTING FROM BREACH OF WARRANTY OR ANY OTHER LEGAL THEORY. IF THE REMEDY ABOVE FAILS, EPSON'S ENTIRE LIABILITY SHALL BE LIMITED TO A REFUND OF THE PRICE PAID FOR THE EPSON PRODUCTS COVERED BY THIS LIMITED WARRANTY.

In Canada, warranties include both warranties and conditions.

Some jurisdictions do not allow limitations on how long an implied warranty lasts and some jurisdictions do not allow the exclusion or limitation of incidental or consequential damages, so the above limitations and exclusions may not apply to you.

This warranty gives you specific legal rights, and you may also have other rights, which vary from jurisdiction to jurisdiction.

To locate the Authorized EPSON Servicer nearest you, call the EPSON ConnectionSM at (800) 637-7661 + PIN or (562) 276-4394 in the U.S. and (905) 709-3839 in Canada or write to: Epson America, Inc., P.O. Box 93012, Long Beach, CA 90809-3012.

C

Appendix C: Technical Specifications

General

Type of display	Poly-silicon Thin Film Transistor (TFT)
Size of LCD panels	Diagonal: 0.9 inches (22.9 mm)
Lens	F=2.0 to 2.2, f=35 to 42 mm
Resolution	713c: 1024 × 768 pixels (native format) 503c: 800 × 600 pixels (native format)
Color reproduction	24 bit, 16.7 million colors
Brightness	713c: 1200 lumens (ANSI) 503c: 1100 lumens (ANSI)
Contrast ratio	400:1
Image size	26 to 300 inches
Projection distance	3.6 to 45.5 feet (1.1 to 13.8 meters)
Projection methods	Front, rear, upside-down (ceiling mount)
Internal sound system	1W monaural
Optical aspect ratio	4:3 (horizontal : vertical)
Zoom ratio	1:1.2
Noise level	42 dB
Keystone correction angle	± 15° (maximum)

Projection Lamp

Type	UHE (Ultra High Efficiency)
Power consumption	150 W
Lamp life	About 1000 hours
Part number	ELPLP14

Remote Control

Range	32.8 feet (10 meters)
Batteries	Alkaline AA (2)

Mouse Compatibility

Supports PS/2, USB, ADB

Dimensions

Height	2.8 to 3.4 inches (72 to 87 mm)
Width	8.4 inches (213 mm)
Depth	10.5 inches (267 mm)
Weight	5.8 lb (2.6 kg)

Electrical

Rated frequency	50/60 Hz
Power supply	100 to 120 VAC, 1.9 A 200 to 240 VAC, 1.0 A
Power consumption	Operating: 230 W Standby: 5 W

Environmental

Temperature	Operating: 41 to 95 °F (5 to 35 °C) Storage: 14 to 140 °F (-10 to 60 °C)
Humidity	Operating: 20 to 80% RH, non-condensing Storage: 10 to 90% RH, non-condensing

Safety

United States	FCC Part 15B Class B UL1950 Rev. 3
Canada	DOC ICES003 Class B CSA C22.2 No. 950 Rev. 3
CE Marking	Directive 89/336/EEC, 92/31/EEC EN 60950

Compatible Video Formats

The projector supports NTSC, PAL, and SECAM international video standards, as well as the monitor display formats listed below.

To project images output from a computer, the computer's video card must be set at a refresh rate (vertical frequency) that's compatible with the projector; see the following table for compatible formats. As noted below, some images are automatically resized to display in one of the projector's "native" formats (such as XGA). In addition, the frequencies of some computers may not allow images to display correctly; see your computer's documentation for details.

Mode	Refresh Rate (Hz)	Resolution
VGAEGA	70	640 × 350
VGA60	59.94	640 × 480
VGA72	72.809	640 × 480
VGA75	75	640 × 480
VGA85	85.008	640 × 480
VGA Text	70.087	720 × 350
VGA Text	70.087	720 × 400
SVGA56	56.25	800 × 600
SVGA60	60.317	800 × 600
SVGA72	72.188	800 × 600
SVGA75	75	800 × 600
SVGA85	85.061	800 × 600
XGA43i	43.476	1024 × 768 ¹
XGA60	60.004	1024 × 768 ¹
XGA70	70.069	1024 × 768 ¹
XGA75	75.029	1024 × 768 ¹
XGA85	84.997	1024 × 768 ¹
SXGA1—70	70.012	1152 × 864 ²
SXGA1—75	75	1152 × 864 ²
SXGA1—85	84.999	1152 × 864 ²
SXGA2—60	60	1280 × 960 ²
SXGA2—75	75	1280 × 960 ²
SXGA2—85	85.002	1280 × 960 ²

Mode	Refresh Rate (Hz)	Resolution
SXGA3—43i	43.436	1280 × 1024 ²
SXGA3—60	60.02	1280 × 1024 ²
SXGA3—75	75.025	1280 × 1024 ²
SXGA3—85	85.024	1280 × 1024 ²
UXGA60	60	1600 × 1200 ³
MAC II 13	66.67	640 × 480
MAC16	75.087	832 × 624 ¹
MAC19—60	59.28	1024 × 768 ¹
MAC19	74.93	1024 × 768 ¹
MAC21	75.062	1152 × 870 ²
NTSC	60	640 × 480 ²
PAL	50	720 × 540 ²
SECAM	50	720 × 540 ²

¹ The image is resized so that it displays using one of the projector's native formats (PowerLite 503c only).

² The image is resized so that it displays using one of the projector's native formats.

³ Not supported on the PowerLite 503c.

Computer Video Port Pin Assignments

The Computer port is a female video RGB, 15-pin micro-D-style connector. Here are its pin assignments:

Pin no.	Computer port
1	Red video
2	Green video
3	Blue video
4	GND
5	GND
6	Red GND
7	Green GND
8	Blue GND
9	Reserved
10	Synchronous GND
11	GND
12	SDA
13	Horizontal sync / composite sync
14	Vertical sync
15	SCL

Index

A

- A/V Mute button, 31, 45
- A/V Mute setting, 47
- About menu, 38, 49
- Accessories, 8, 70
- Adapters, Macintosh, 77 to 78
- Adobe Acrobat Reader, 3 to 4
- Advanced menu, 38, 48 to 49
- Air filter, cleaning and replacing, 53 to 54
- Anti-theft device, 8, 11
- Aspect ratio, 89
- Audio
 - adjusting tone, 42
 - adjusting volume, 30, 42
 - connecting desktop, 76, 79
 - connecting laptop, 14
 - connecting video device, 15 to 16
 - menu, 38, 42
 - outputting to external sound system, 72 to 73
 - problems, troubleshooting, 67
 - turning off (using A/V Mute), 31
- Audio Out jack, 73
- Auto button, 40
- Auto Setup setting, 41
- AV cable, 15 to 16

B

- Bass, adjusting, 42
- Batteries, installing, 28
- Blurry image, 65
- Box tool
 - customizing, 43 to 44
 - using, 34
- Brightness, 1, 89
- Brightness setting, 41

C

- Cables, 6 to 8
- Camcorder, connecting to, 15 to 16
- Carrying case, 8, 56
- CD-ROMs, 4
- Ceiling mount, 8, 49, 72
- Cleaning
 - air filter, 53 to 54
 - lens, 52
 - projector case, 52
- Color
 - adjusting, 41, 48
 - problems, 66
- Comp button, 30, 67
- Composite video cable, 15
- Computer cable, 6
- Computer connector pin assignments, 94
- Connecting projector
 - to a desktop Macintosh, 77 to 79
 - to a desktop PC, 73 to 76
 - to a high-end workstation, 79
 - to a laptop, 12 to 14
 - to a video source, 15 to 16
- Connector pin assignments, 94
- Contrast setting, 41
- Cursor speed, setting, 43
- Cursor/Stamp tool
 - customizing, 43 to 44
 - using, 34

D

- Declaration of Conformity, 84
- Default settings, restoring, 39, 50
- Desktop adapter, Macintosh, 77 to 78
- Desktop computer, connecting to, 73 to 79
- Digital camera, connecting to, 15 to 16
- Distance from projector to screen, 10
- Drawing on the screen, 33 to 36
- DVD player, connecting to, 15 to 16

E

- Effect menu, 38, 43 to 44
- Electrical specifications, 90
- Enter button, 29
- Environmental specifications, 91
- EPSON
 - accessories, 8, 70
 - PrivateLine Support, 5, 69
 - technical support, 4, 69 to 70
- Esc button, 36
- External speakers, connecting to, 72 to 73
- E-Zoom button, 31

F

- FCC compliance statement, 85
- Filter
 - See Air filter
- Focusing, 23
- Foot release levers, 23
- Freehand line tool
 - customizing, 43 to 44
 - using, 35 to 36
- Freeze button, 31

G

- Gamma setting, 41

H

- Height of image, adjusting, 23
- Help, 4 to 5, 69 to 70
- Help button, 58
- Help system, using, 58
- Highlighting tools, 33 to 36

I

- iBook, connecting to, 12 to 14
- iMac, connecting to, 7

Image

- adjusting, 22 to 24, 40 to 41
- capturing and saving in projector, 44 to 45
- correcting shape of, 24, 46, 64
- focusing, 23
- height, adjusting, 23
- positioning, 23, 40
- problems with, troubleshooting, 62 to 67
- raising, 23
- resizing, 32
- shape, correcting, 24, 46, 64
- size and projection distance, 10
- size range, 89
- turning off (using A/V Mute), 31
- zooming, 23, 31

- Installing projector, 72 to 73

K

- Kensington anti-theft device, 8, 11
- Keystone button, 24
- Keystone correction, 24, 64, 89

L

Lamp

- automatic shutoff, 25
- number of hours used, 49
- replacing, 54 to 56
- specifications, 90
- status light, 59

- Language setting, 48, 58

Laptop computer

- connecting to, 12 to 14
- displaying on, 22, 63

- Laser disc player, connecting to, 15 to 16

Lens

- cap, 19
- cleaning, 52
- extending, 18
- specifications, 89

- Light button (on remote control), 28

- Lights, status, 59 to 62

- Lines, drawing on screen, 35 to 36

- Logo, saving on projector, 44 to 46

M

- Macintosh, connecting to, 77 to 79
- Manuals, 3 to 5
- Marker tool
 - customizing, 43 to 44
 - using, 35
- Menus
 - About, 38, 49
 - Advanced, 38, 48 to 49
 - Audio, 38, 42
 - changing settings, 38 to 39
 - Effect, 38, 43 to 44
 - Reset All, 38, 50
 - Setting, 38, 46 to 47
 - User's Logo, 38, 44 to 45
 - using, 38 to 39
 - Video, 38, 40 to 41
- Monitor adapter, Macintosh, 77 to 78

N

- No-Signal Msg setting, 45, 47

O

- Options for projector, 8

P

- P in P (picture in picture) button, 32 to 33
- Picture
 - See Image
- Picture-in-picture video source, selecting, 46
- Pin assignments, connector, 94
- Pointer tool
 - customizing, 43 to 44
 - using, 34
- Positioning image, 23
- Positioning the projector, 10 to 11, 72
- Power
 - button, 19
 - consumption, 90
 - saving, 25, 47
 - status light, 59
 - supply, 90

- PowerBook, connecting to, 12 to 14
- Presenters Online, 4, 69
- PrivateLine Support, 5, 69
- Problems
 - color, 66
 - image, 62 to 66
 - remote control, 68, 83
 - sound, 67
- Projection lamp
 - See Lamp
- Projector
 - carrying case, 8, 56
 - cleaning, 52
 - distance from screen, 10, 89
 - feet, adjusting height with, 23
 - installing, 72 to 73
 - lamp specifications, 90
 - options, 8
 - positioning, 10 to 11
 - resolution, 1, 89
 - shutting off, 25
 - software, 4
 - specifications, 89 to 94
 - transporting, 56
 - troubleshooting, 57 to 67
 - turning off, 25
 - turning on, 18 to 20
 - unpacking, 6 to 7
 - viewing information about, 49
- Prompt setting, 47
- PS/2 mouse cable, 6
- Public address system, connecting to, 72 to 73

R

- Raising image, 23
- RCA AV cable, 15 to 16
- Rear-screen projection, 48, 72
- Registration, 5

- Remote control
 - light button, 28
 - numbered buttons, 33
 - problems, 68, 83
 - specifications, 90
 - troubleshooting, 68, 83
 - turning on, 28
 - using, 27 to 36
 - wireless mouse, using as, 36
- Replacing lamp, 54 to 56
- Reset All menu, 38, 50
- Resetting menu options, 39, 50
- Resize button, 32
- Resizing image, 32
- Resolution, 1, 89

S

- Safety instructions, 81 to 83
- Screen image
 - See* Image
- Screen, distance from projector, 10
- Screens, portable, 8
- Setting menu, 38, 46 to 47
- Sharpness setting, 41
- Sleep mode, 25, 47
- Software, 4
- Sound
 - See* Audio
- Source button, 20
- Source, selecting, 30
- Speaker, specifications, 89
- Speakers, connecting to, 72 to 73
- Special effects buttons, 33 to 36
- Specifications
 - brightness, 1, 89
 - electrical, 90
 - environmental, 91
 - general, 89
 - lamp, 90
 - lens, 89
 - remote control, 90
 - resolution, 1, 89
 - safety, 91
- Startup Screen setting, 48

- Startup screen, creating, 44 to 46
- Status lights, 59 to 62
- Stopping action, 31
- Support
 - See* Technical support
- S-video, 15
- S-Video button, 30
- S-video cable, 7
- Sync, adjusting, 41

T

- Technical support, 4, 69 to 70
- Temperature
 - requirements, 91
 - status light, 59
- Tint setting, 41
- Tone setting, 42
- Tracking, adjusting, 41
- Transporting projector, 56
- Treble, adjusting, 42
- Troubleshooting
 - image and sound problems, 62 to 67
 - projector problems, 57 to 67
 - remote control problems, 68
- Turning off picture (using A/V Mute), 31
- Turning off projector, 25
- Turning on projector, 18 to 20

U

- Unpacking projector, 6 to 7
- USB mouse cable, 6
- User's Logo menu, 38, 44 to 45

V

- VCR, connecting to, 15 to 16
- Video
 - button, 30
 - display settings, viewing, 49
 - formats, supported, 1, 92 to 93
 - menu, 38, 40 to 41
 - picture in picture, 46
 - selecting source, 30
- Video port pin assignments, 94

Video sources, connecting to, 15 to 16

Volume

button, 30

setting, 42

W

Warning lights, 59 to 62

Warranty, 5, 86 to 87

Workstations, connecting projector to, 79

Z

Zoom ratio, 89

Zooming image, 23, 31